

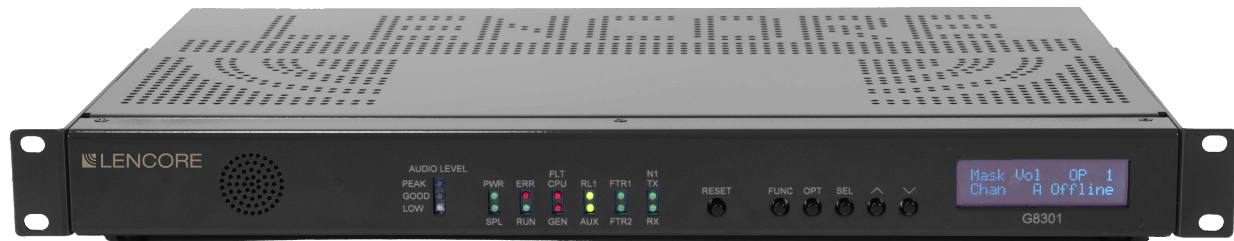

COMFORT. PRIVACY. PRODUCTIVITY.



GOLD™

DESIGN, INSTALLATION AND
OPERATION GUIDELINES
(Model A1U)

table of contents

INTRODUCTION	1
Diagram	2
Wiring	4
Connections	4
Configuring the System	6
Flow Diagram	7
System Zoning	8
Speaker Layout	9
Installation	12
IR Wall Controls	20
Tuning and Balancing	23
Changing the IP Address	33
Operating the System from the Front Panel	34
Troubleshooting Speaker Lines	40

IMPORTANT SAFETY INSTRUCTIONS



**RISK OF ELECTRIC SHOCK- DO NOT OPEN THE UNIT.
THERE ARE NO SERVICABLE COMPONENTS INSIDE.**

- 1) Read these instructions.
- 2) Keep these instructions.
- 3) Heed all warnings.
- 4) Follow all instructions.
- 5) Do not use this apparatus near water.
- 6) Clean only with dry cloth.
- 7) Do not block any ventilation openings. Install in accordance with the manufacturer's instructions.
- 8) Do not install near any heat sources such as radiators, heat registers, stoves, or other apparatus (including amplifiers) that produce heat.
- 9) Do not defeat the safety purpose of the polarized or grounding-type plug. A polarized plug has two blades with one wider than the other. A grounding type plug has two blades and a third grounding prong. The wide blade or the third prong are provided for your safety. If the provided plug does not fit into your outlet, consult an electrician for replacement of the obsolete outlet.
- 10) Protect the power cord from being walked on or pinched particularly at plugs, convenience receptacles, and the point where they exit from the apparatus.
- 11) Only use attachments/accessories specified by the manufacturer.
- 12) Use only with the cart, stand, tripod, bracket, or table specified by the manufacturer, or sold with the apparatus. When a cart is used, use caution when moving the cart/apparatus combination to avoid injury from tip-over.
- 13) Refer all servicing to qualified service personnel. Servicing is required when the apparatus has been damaged in any way, such as power-supply cord or plug is damaged, liquid has been spilled or objects have fallen into the apparatus, the apparatus has been exposed to rain or moisture, does not operate normally, or has been dropped.
- 14) **WARNING** To reduce the risk of fire or electric shock, do not expose this apparatus to rain or moisture and do not expose to dripping or splashing and no objects filled with liquids, such as vases, shall be placed on the apparatus

Lencore Gold™ Sound Masking System Planning and Layout Guideline

Lencore provides layout and wiring diagrams at no cost – we encourage you to contact us with your project information at www.lencore.com/Request-a-Quote, rfq@lencore.com or 516-682-9292.

The following pages include design, installation and operation guidelines utilized to reach the best possible performance from the Lencore sound masking system. The goal of a sound masking system is to provide speech privacy by raising the ambient background noise with a comfortable sound that is uniform throughout the space.

The Gold All-Inclusive Unit also provides for one music input source - such as an iPod, or other device (not included), through an RCA jack. Music can be zoned separately from the sound masking.

Gold

Lencore's Gold unit is an out of the box, stand-alone system incorporating amplifiers, equalizers, zone modification and total control in one unit. The Gold unit is a 1RU rack mount unit that offers two Operating Platforms (OPs) and a head-end in one unit. The system maintains the easy to use full one third octave band equalizer that can be adjusted to either individual zones or all zones and provides exceptional fine-tuning capabilities. Groupings of sound sources and channels let you customize an almost limitless number of zones (up to 255) for masking and music, while maintaining the advantages of complete networked operation and control.

The creation, modification, addition and deletion of zones for sound masking and music can be easily controlled using the included Lencore System Manager or through the on-board buttons. No proprietary software needs to be installed on the client's side, eliminating security and migration issues. The Lencore Gold unit is an open platform system. In addition, volume and equalizer settings for sound masking and music can be programmed through System Manager offering tremendous adjustment and control capabilities with unprecedented flexibility.

Sound Masking Speakers

The Gold system utilizes either 4" direct-fired or 6" in-plenum speakers. Direct-fired speakers are either mounted in the ceiling (Gold Direct Fired Tangent) or attached to the ceiling / deck (Gold Decorative Pendant) and face downward for direct, unimpeded delivery of the sound. Gold in-plenum speakers are mounted above the ceiling, in the plenum space between the ceiling and the deck above; they fill the plenum with sound which then filters down through the ceiling into the space below. Because of the difference in the way that the sound is dispersed there are different design and layout guidelines based on which speaker system is being used. All speakers are powered through the headend device via Cat5e RJ45 cables.



Gold Direct Fired Tangent



Gold In-Plenum Universal

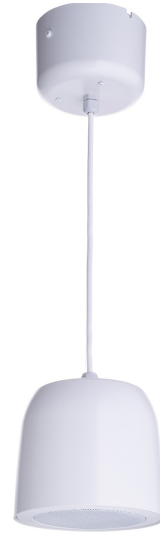

Gold Decorative Pendant

Headend

The Gold 1 RU rack mounted or stand-alone headend contains all of the controls and processors for generating the sound masking. It also has one RCA audio input for adding background music which is controlled independently of the sound masking. This headend control is simple to install and easy to maintain either directly on the unit itself or through the graphic user interface named System Manager.



Front Panel

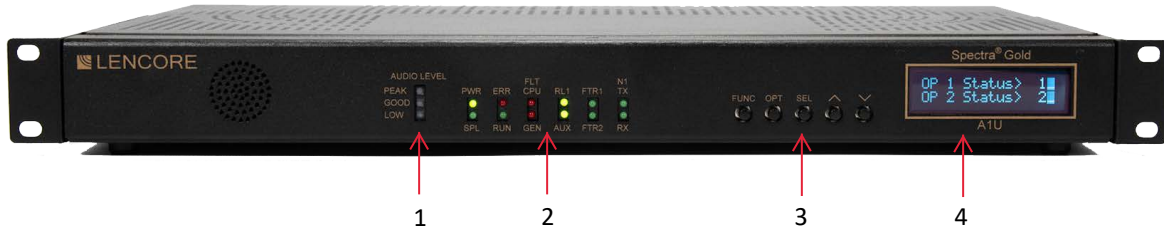

Rear Panel

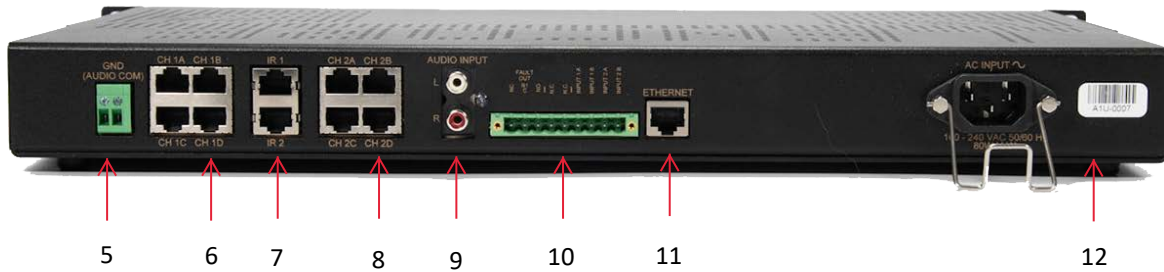

1. Audio Level LEDs

The Audio Level LEDs indicate the audio input level as low, good, or clipped.

2. LED Indicators

The LED indicators display various conditions and functions such as network activity and relay status. See "Using the System" for detailed information.

3. Buttons

The switches are used to make a number of adjustments to the system without using a computer.

4. LCD display

The LCD displays various diagnostic messages and configuration information about the system.

5. GND

For external auxiliary equipment.

6. OP1 speaker connectors

Speaker connectors for OP1 channels A, B, C, and D using RJ45 connectors.

7. IR Inputs

Connect the IR input to a Lencore's IR device using an RJ45 cable for OP1 and OP2.

8. OP2 speaker connectors

Speaker connectors for OP2 channels A, B, C, and D using RJ45 connectors.

9. RCA Audio Input

Connect a line level audio source using an RCA cable.

10. AUX connector

Connector for external equipment.

11. Ethernet

Connect an Ethernet cable to access the Processor.

12. Power Input

Power cord connector (IEC 60320). 100-240VAC.

Wiring

Power and Network connections:

1. Plug the unit into a standard 115VAC power outlet. The system will be usable in approximately two minutes. The AUX LED will flash while the system is booting-up and be solid when the system is ready.
2. Connect a network cable to the unit's Ethernet input to access the Protoceptor. The Protoceptor is the network server. The Protoceptor is pre-loaded with Lencore's System Manager. System Manager allows adjustment to the system's characteristics.
Note: The network cable must be a standard Ethernet cable not power over Ethernet (POE).

ETHERNET

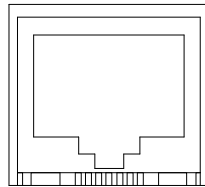

Ground connection:

1. For future use in expandable interface solutions.

GND (AUDIO COM)

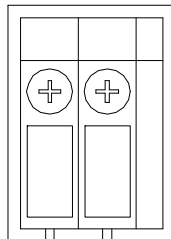

IR connections:

1. Connect an IR unit to the IR port.
IR1 for OP1 speakers.
IR2 for OP2 speakers.

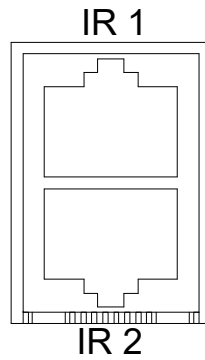

Speaker connections:

1. Connect the external speakers to the appropriate channel using cat 5 RJ45 cables.

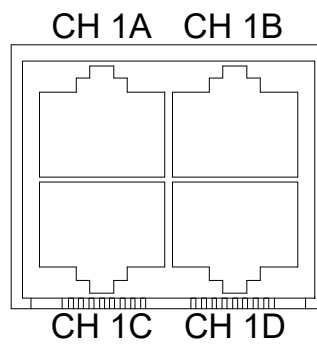

Auxiliary Connection

Connect an external device's fault input to Aux "Fault Out" Relay R1 - NC and C. Relay R1 is energized (closed) when no fault exists and de-energized (open) when a fault is active. Input 1A and 1B are for future use. Input 2A and 2B are for future use.

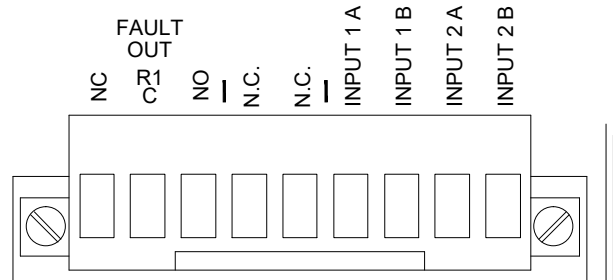

Configuring the System

The system must be configured before the music function is used. The switches can be used to configure and adjust the system for many functions. System Manager must be used to create any zones or to make more detailed adjustments such as equalizer settings. See below for switches usage and System Manager operations.

Front Panel Switches:

The switches allow the user to make a number of adjustments to the system without using a computer, although, a computer and System Manager are still required for full control of all functions. A selection can be made by continually pressing and releasing the switch.

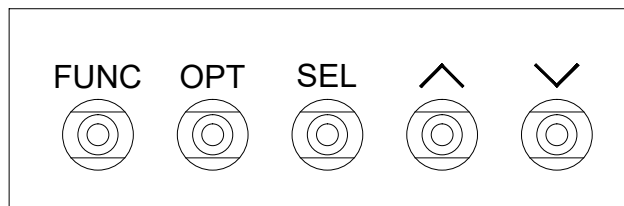

Flow Diagram

Back View

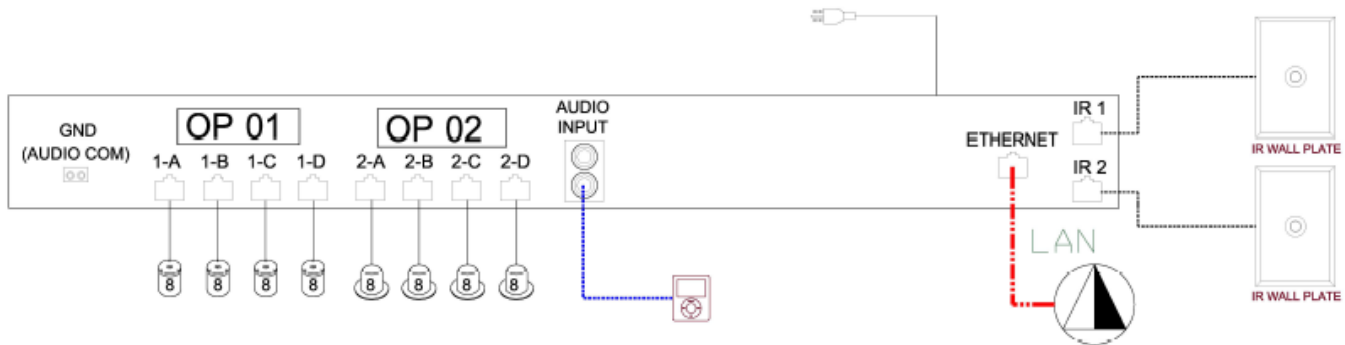

***Diagram above is for wiring purposes only and is not an exact representation of the actual unit**

Gold utilizes both direct fired (Gold Direct Fired Tangent and Gold Decorative Pendant) and indirect firing (Gold Universal In-Plenum) speakers. Based on the space and the layout, each channel can accommodate up to 8 speakers per channel. Speakers on each channel are daisy-chained together.



1 to 8 Speakers per Channel

Cabling Types and Distances

The advantage to Gold sound masking over other systems is the use of UTP four pair / category type cabling with EIA/TIA 568B standard termination. Recommended CMP type cabling (plenum rated cable), is NOT supplied as part of the system. Contact your local supplier for cable.

Home run cabling (typically supplied and cut to length in the field by the installer) is a "Signal Cable" found between the Gold headend OP Channel and the first speaker on that channel. There are eight (8) channels on the Gold headend and up to eight (8) speakers per channel (for a total of 64 speakers).

Interconnect cables are utilized by both types of speakers. Connect the Output jack of a previous speaker to the Input jack of the next speaker in a daisy chain fashion.

Cable	Cabling Type	Speaker
Signal Cable West Penn 254245 Belden 1701A or Equivalent	Category 5, 5e, 6 / 4-Pair (8 Conductor) 24 AWG Solid CMP	300 ft from headend to last speaker

System Zoning

Note: Lencore provides design layout at no cost. Speaker placement, zones and channel assignments are all complimentary as part of the Lencore design process. Contact Lencore today at 516-682.9292.

Zoning is determined by the function of the space being served by sound masking as well as ceiling height. For example, separate zones are used for open offices, private offices, and corridors due to their requirement for differing sound masking volumes.

Another decision point for the number of zones required are areas requiring other audio sources (i.e. background music). The audio input features an audio adjustment on each zone allowing an audio source to be tailored to any “specific” or “combination” of zones.

In cases where variation in ceiling heights of greater than 6” occur, multiple zones are required within the same functional space to meet the goal of a consistent sound masking signal being delivered to occupants. For example, a single open office with speakers placed in acoustic ceiling tile at a height of 9’8” and drywall soffit at 9’ will require each area be served by separate zones. This separation allows adjustment of sound masking levels at the listener location based on speaker distance.

As a rule, sound masking zones should begin and end at the physical boundaries whenever possible. This means that coverage of a space should extend from wall to wall eliminating areas where occupants can exit and enter sound masking within the same space. Failure to follow this guideline will often lead to occupant complaints due to the audible shift from “masked” to “non-masked” environment.



- Zone 1 - Open Office - Sound Masking
- Zone 2 - Private Office - Sound Masking
- Zone 3 - Conference Room - Sound Masking
- Zone 4 - Reception/Kitchen - Sound Masking + Music

Large Space / Open Office Speaker Spacing

Speakers are typically placed in or above a ceiling in a consistent square / rectangular grid pattern with the ultimate goal of providing uniform sound coverage throughout a space. In cases where an open ceiling or partial ceiling exists, optional brackets allow for constant height attachment to wood, structural steel, and flush mounting in solid surfaces such as drywall and wood panels. Speaker spacing is based on ceiling / mounting height.

Lencore speakers have the same minimum and maximum spacing requirements from acoustic boundaries such as walls or columns. If a device is too close or too far away from a boundary, a change in sound level may be discernible by occupants and should be avoided.

In the case where an in-ceiling conflict occurs (i.e., a light fixture, exit sign, sprinkler head), it is permissible to move a speaker up to 2' in any direction to avoid the conflict. However, ensure that the most consistent spacing possible is achieved to keep variations to a minimum.

Open Area Direct Fired Speaker Spacing Requirements

Speaker Mounting (Ceiling) Height*	Gold Tangent Spacing, "D" (ft) 2x2 ACT, Open, or Solid Surface Ceiling	Gold Tangent Spacing, "D" (ft) 2x4 ACT Ceilings	Minimum Distance to Wall / Obstacle	Maximum Distance from Wall / Obstacle	Maximum Movement Distance to Avoid a Conflict
<8' to 9'	8' x 8'	8' x 8'	2'	4'	Up to 2' in any Direction
9' to 10'	10' x 10'	10' x 8'	2'	5'	Up to 2' in any Direction
10' to 11'	10' x 10'	10' x 8'	2'	5'	Up to 2' in any Direction
11' to 12'	12' x 12'	12' x 12'	2'	6'	Up to 2' in any Direction
12' to 14'	12' x 12'	12' x 12'	2'	6'	Up to 2' in any Direction
14'+	Call Lencore	Call Lencore	2'	7'	Up to 2' in any Direction

Open Area indirect Fired Speaker Spacing Requirements

(Ceiling) Height	(Plenum) Height	Gold In-Plenum Speaker Spacing	Minimum Distance From Wall/Obstacle	Maximum Movement
8' - 12'	3 - 5'	15'	2'	Up to 2' in any Direction

*If using Gold Decorative Pendant Speakers the height references the height that the speaker face rests at

In many cases it will be necessary to adjust the last row or last several rows of speakers to compensate for room dimensions. In these cases, it is important to lessen the distance between speakers to maintain adequate coverage rather than increasing it. In 2x2 ceiling tile this can be done by moving the speaker by one tile (-2') as shown in the example below.

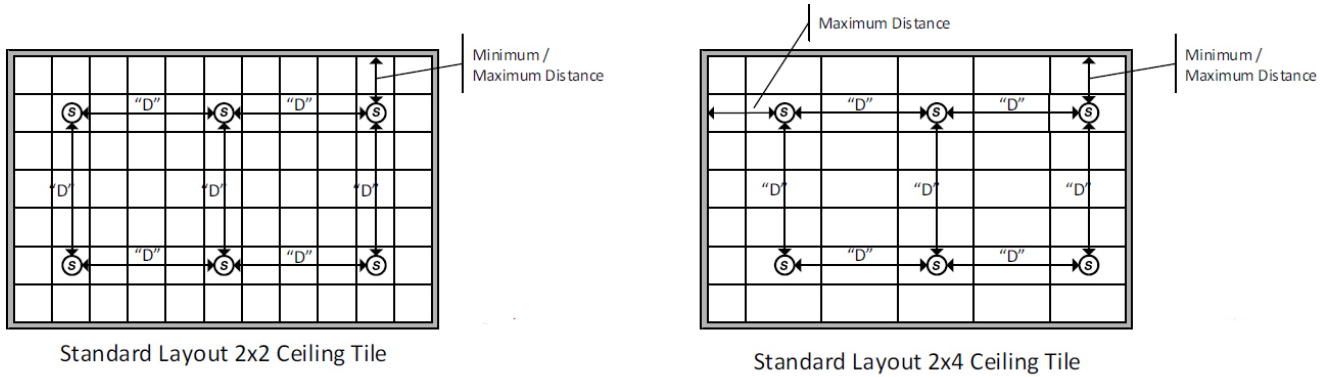

Due to aesthetic concerns it is often desirable to keep the speaker location centered in the ceiling tile. The above example shows a 10' x 8' grid in use in 2'x4' ceiling tiles to accomplish this goal. This approach may be used in cases where ceiling height would allow for 10'x10' spacing but the aesthetic impact is objectionable.

Enclosed Rooms / Private Offices Speaker Spacing

Enclosed offices and most smaller enclosed spaces require a minimum of two speakers per space to prevent listeners within the space from focusing on a single speaker location. The number of speakers for such spaces can easily be determined utilizing the table below:

Number of Speakers in a Small Enclosed Area

Enclosed Area (Sqr. ft.)	Number of Speakers	Recommended Layout
Up to 180	2	
180 to 260	3	
261 to 340	4	
341 to 420	5	
420 to 500	6	
Greater than 500	Use Large Area / Open Office Guidelines	

Telephone Rooms / Exam Rooms / Mother's Rooms Speaker Spacing

It is permissible to install a single speaker in very small spaces to gain privacy where the duration of occupancy is limited and specific installation conditions can be met. Such spaces include dedicated "Telephone rooms" in office environments or "Exam Rooms" in a clinic environment. A single speaker is an acceptable means of coverage if the following statements are true:

1. Occupancy is typically less than 1 hour per visit
2. The area of room is less than or equal to the room size below based on ceiling heights.
3. A dedicated zone is used for similar use single speaker rooms allowing for adequate adjustment.

Acceptable Use of a Single Speaker for Coverage

Ceiling Height	Maximum Room Size	Sound Masking Exposure Duration
8' to 9'	< 64 square feet	Less than 1 Hour
9' to 11'	< 100 square feet	Less than 1 Hour
11' to 14'	< 144 square feet	Less than 1 Hour
Above 14'	Call Lencore	Less than 1 Hour

In cases where the time duration of exposure, the room size is exceeded in reference to ceiling height, or the speaker location is offset due to ceiling conflicts, refer to Table 3 above for multiple speaker placement.

Hallways / Corridor Area

Speaker spacing in hallways and corridors should adhere to the same spacing standards as used for larger open offices with the distance between speakers being based on speaker mounting / ceiling heights. Minimum and maximum distances from walls and other obstructions should also be maintained as outlined for open space sound masking deployment. (See Table 2.)

It is preferred that hallway / corridor areas be treated as a separate sound masking zone to allow for independent level adjustment in most applications. This is especially important when adjoining areas of lower sound masking levels such as private offices. An exception can occur however when open office spaces are connected to a hallway or corridor as follows:

1. When larger (width) hallways extend from an open office area it is permissible to continue the open office zone into the hallway with no level adjustment. This may occur when hallway width is greater than the speaker spacing used for the open office.
2. In cases where hallway width is less than the speaker spacing used in the open office, a separate zone should always be used.

INSTALLATION INSTRUCTIONS FOR HEADEND UNIT

RACK MOUNTED

The Gold unit is designed to be installed in a standard 19" rack. Use four of the appropriate screws designed for the rack to mount the unit.

IMPORTANT: A 1RU of empty space is required immediately above the Gold unit for heat dissipation. Failure to leave a 1RU of empty space above the unit can result in the unit overheating and eventual failure.

WALL MOUNTED

1. Unscrew bracket from headend unit.
2. Reorient bracket to have the lower 4 holes on the bracket align with the upper 4 holes on the headend as shown on the diagram.
3. Fasten bracket to headend using supplied screws.
4. Secure bracket with fasteners (not included) to the wall as shown on the diagram.

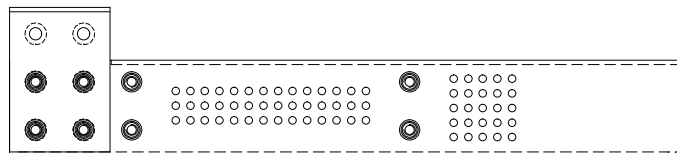
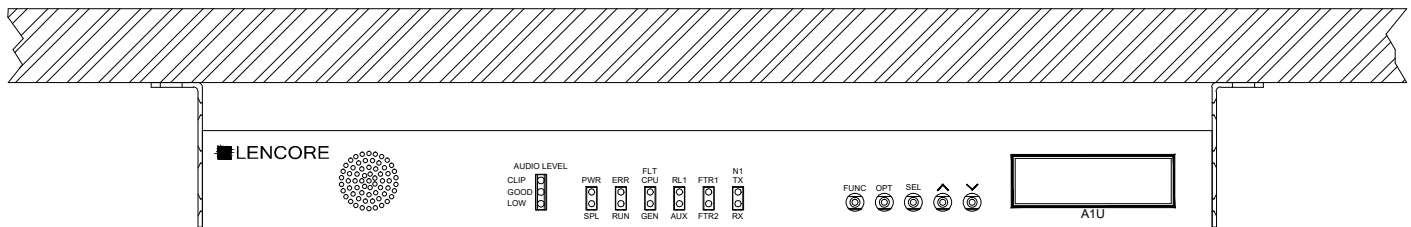

INSTALLATION INSTRUCTIONS FOR GOLD DIRECT FIRED TANGENT SPEAKERS

For additional support, please see our speaker installation videos on the Lencore website at: www.lencore.com

1. Cut a 4.5" hole in the drywall or acoustical ceiling tile
2. Install the Cat 5e cable with standard RJ45 connector into the speaker
3. While lifting both torsion springs into a vertical position, slide the speaker into the hole until the grill is flush with the drywall or acoustical ceiling tile; the torsion springs should hold the speaker firmly in place

Note: If a *tile bridge is being installed: After hole is cut in the tile, lay tile bridge across the suspension grid. Push the torsion springs back on speaker and put speaker through both ceiling tile and tile bridge before releasing springs to hold speaker in place in tile bridge.

**A load-bearing T-bar support designed to sustain the weight of a direct fired Tangent speaker in suspended ceiling construction. Use of the Tile Bridge improves environmental safety and eliminates unsightly sag in 2'-by-2' and 2'-by-4' acoustic ceiling tiles.*

Please comply with all applicable building codes for installation. Lencore does not take responsibility for installation of speakers, wiring or equipment.

WIRING INSTRUCTIONS

1. For first speaker connection to OP: Connect the audio cable— 8 conductor CAT5 from OP channel (either A, B, C, or D) to INPUT of speaker.
2. For speaker to speaker connection: Connect audio cable— 8 conductor from OUTPUT of previous speaker to INPUT of next. Follow the same series connections to add up to 8 speakers per channel. The last speaker in any channel will have only one cable going to its INPUT only. There will be no cable connected to the output.

INSTALLATION DIAGRAMS

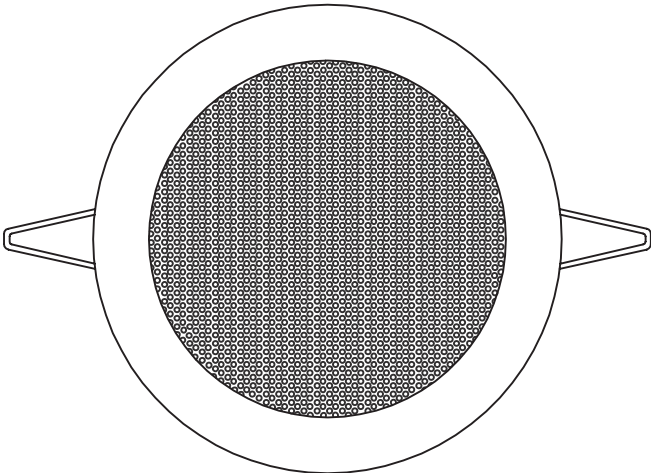

Top

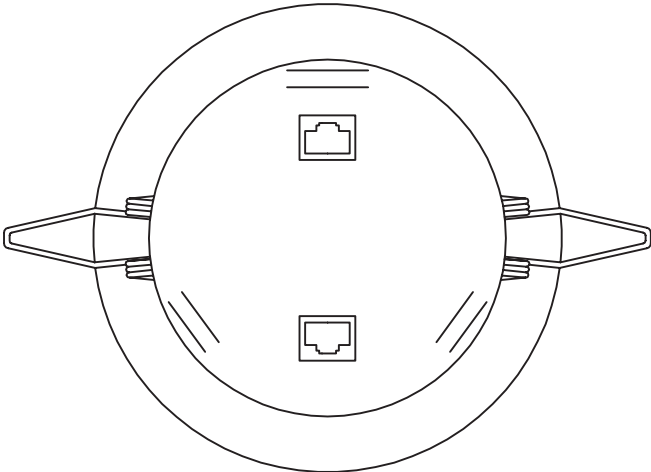

Bottom

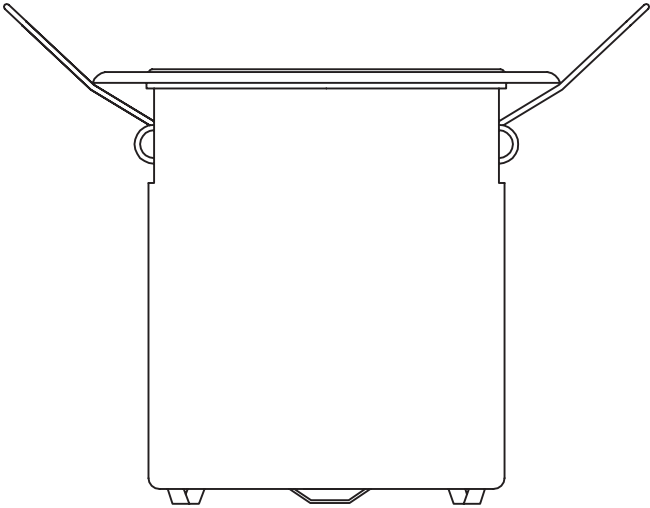

Side

INSTALLATION DIAGRAMS

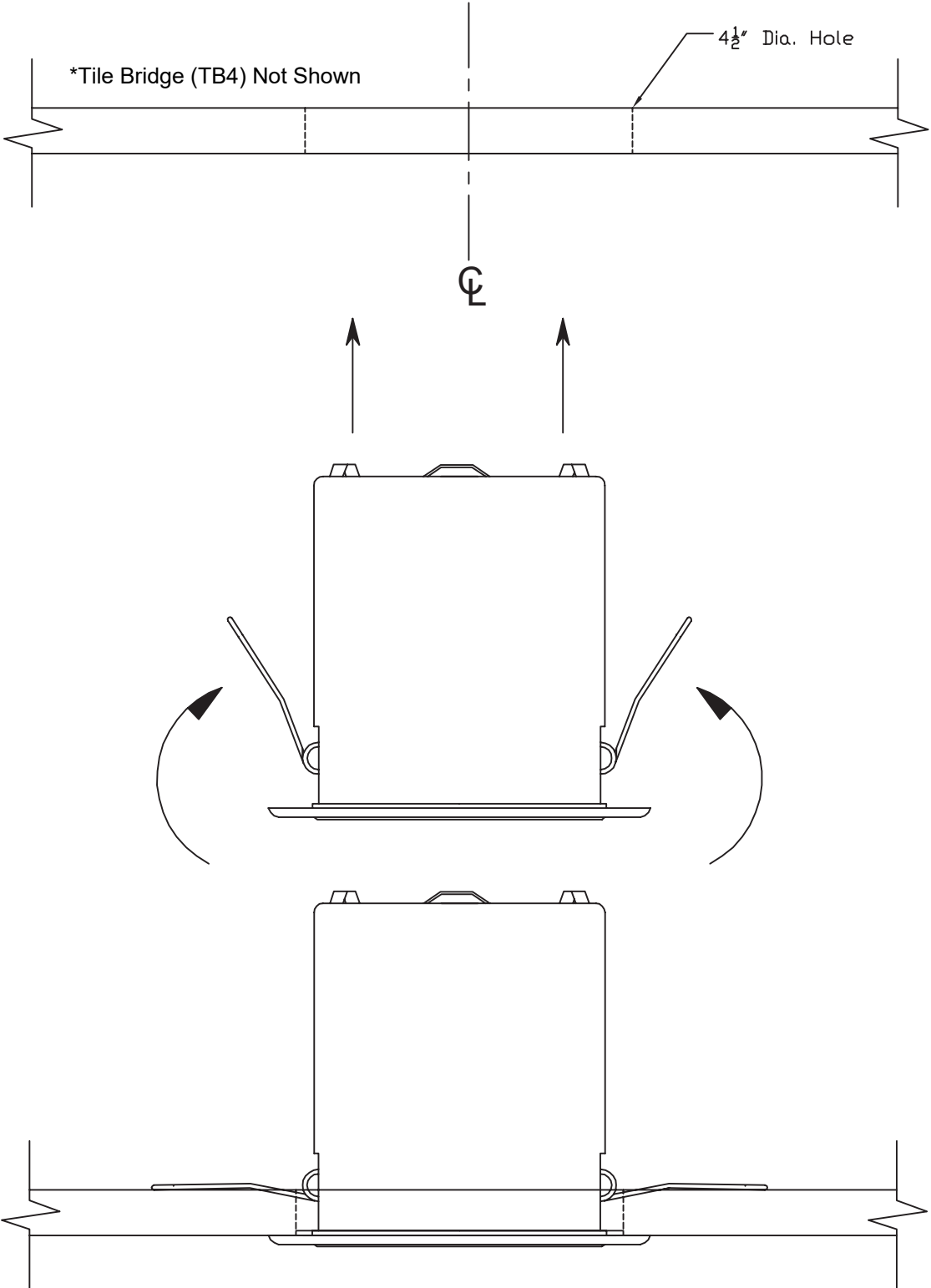

For additional Technical Support call: 516-682-9292

INSTALLATION INSTRUCTIONS FOR GOLD DECORATIVE PENDANT SPEAKERS

For additional support, please see our speaker installation videos on the Lencore website at: www.lencore.com

1. Refer to the sound masking layout (drawing) provided to locate the appropriate speaker installation position.
2. Secure speaker mounting plate to ceiling octagon box
3. Install the Cat5e cable with standard RJ45 connector into the speaker and out through the two large holes in the mounting plate.
4. Secure gem box to mounting plate with two 8-32 x 1/2" screws.

wiring

1. For first speaker connection to OP: Connect the audio cable– 8 conductor CAT5 from OP channel to INPUT of speaker.
2. For speaker to speaker connection: Connect audio cable– 8 conductor from OUTPUT of previous speaker to INPUT of next. Follow the same series connections to add up to 8 speakers per channel. The last speaker in any channel will have only one cable going to its INPUT only. There will be no cable connected to the output.

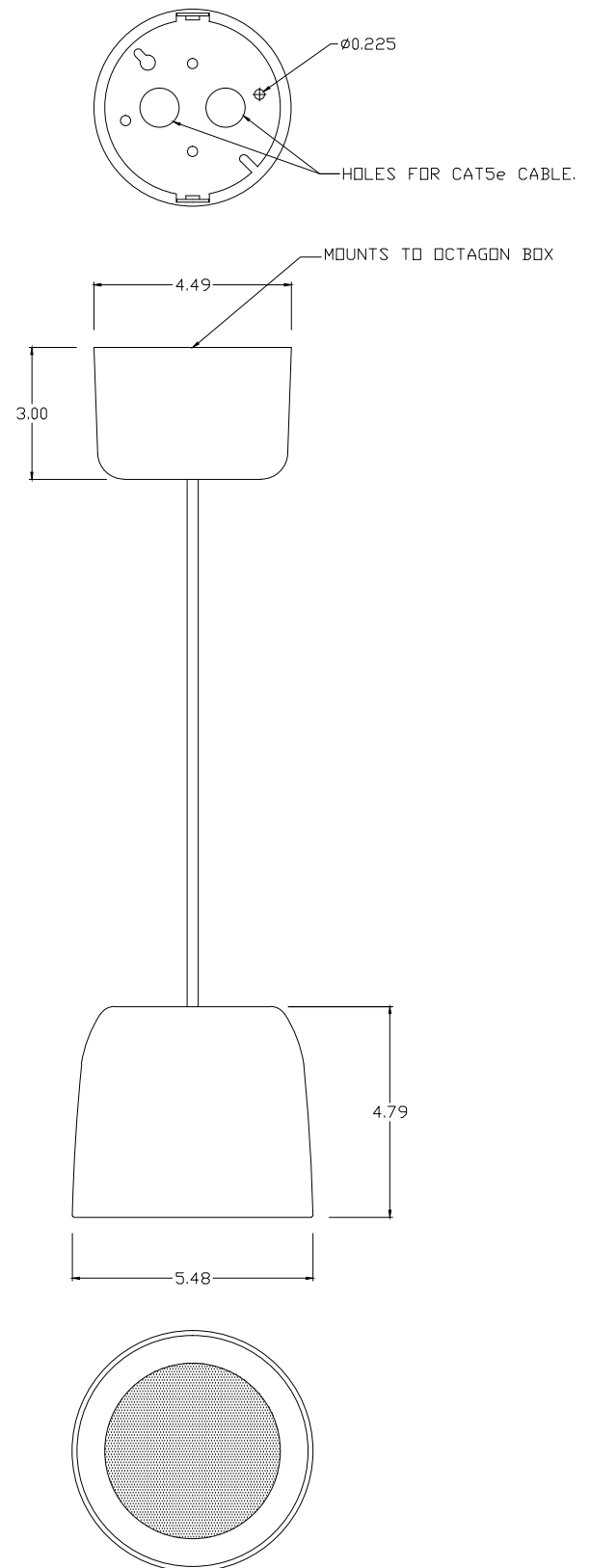

Gold Decorative Pendant Speaker

installation diagram

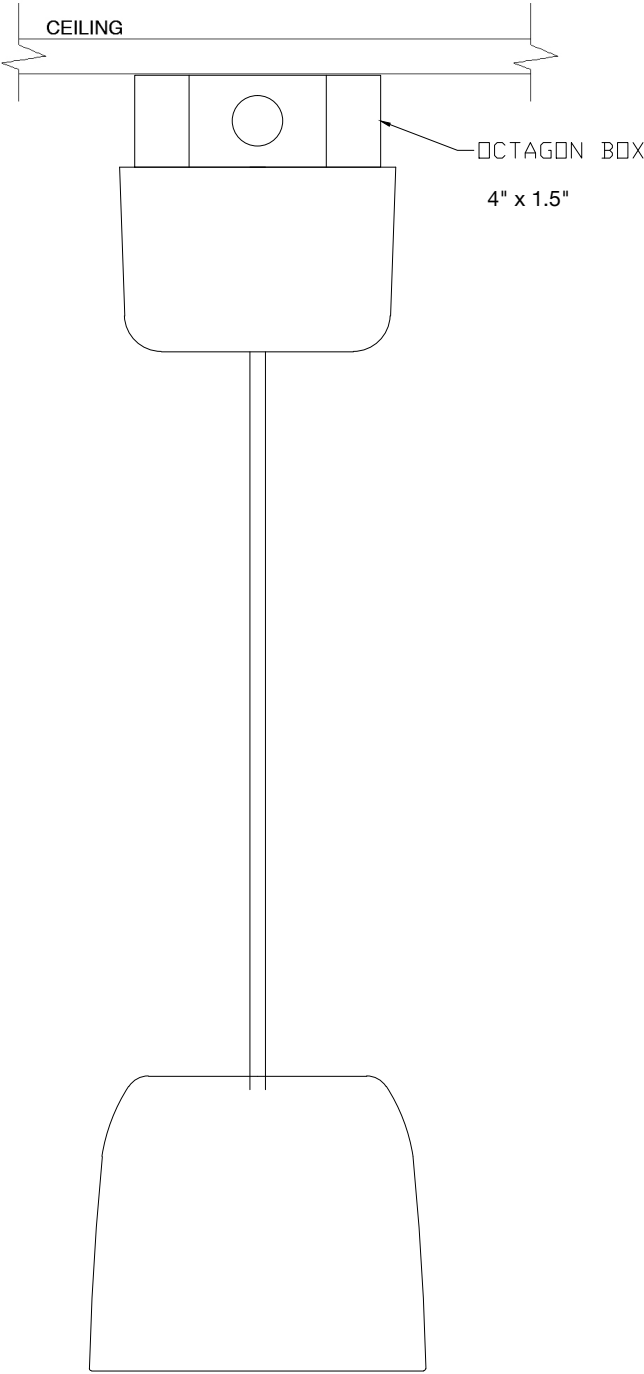

INSTALLATION INSTRUCTIONS FOR THE GOLD IN-PLENUM UNIVERSAL SPEAKER

For additional support, please see our speaker installation videos on the Lencore website at: www.lencore.com

1. Access the ceiling plenum.
2. Orient speaker to face the speaker grill upwards or downwards based on project design and affix enclosed tripod chain to lances on either end.
3. Hang speaker units in plenum area at marked locations using preferred hanging method (powder action gun such as a Hilti-gun™ or drill and screw; check your local building codes for allowable hanging methods and standards).
4. Drive a nail holding the clip with the speaker chain and speaker into deck.

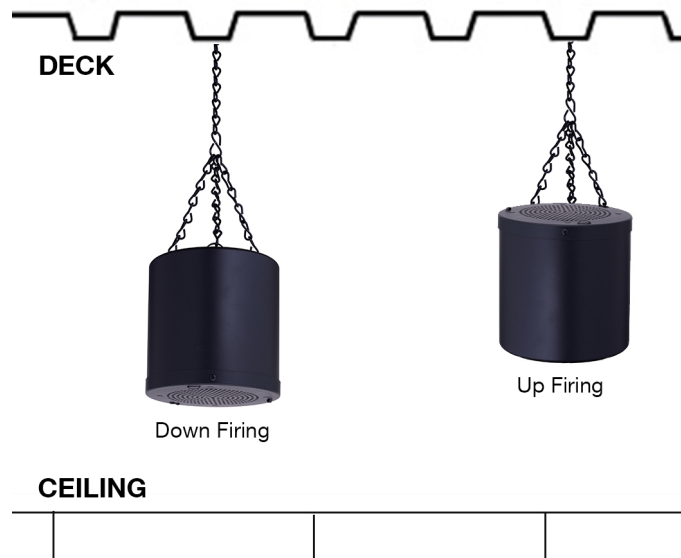

*** Note: keep speakers installed at consistent heights (refer to diagram on page 5)**

Please comply with all applicable building codes for installation. Lencore does not take responsibility for installation of speakers, wiring or equipment.

INSTALLATION DIAGRAMS

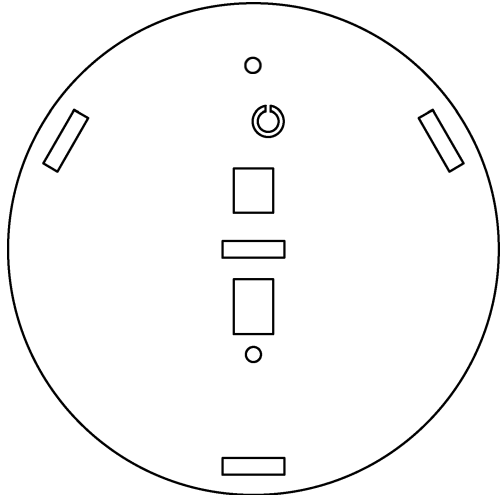
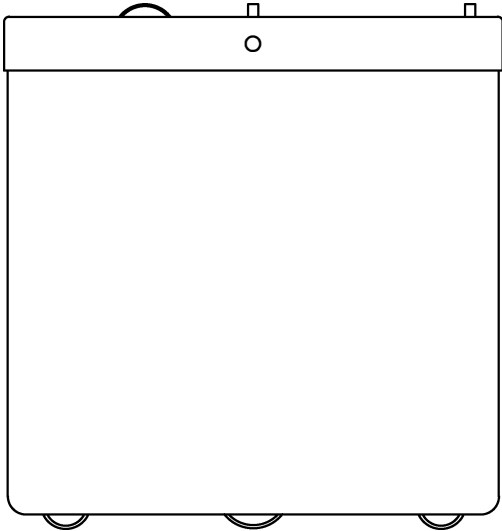
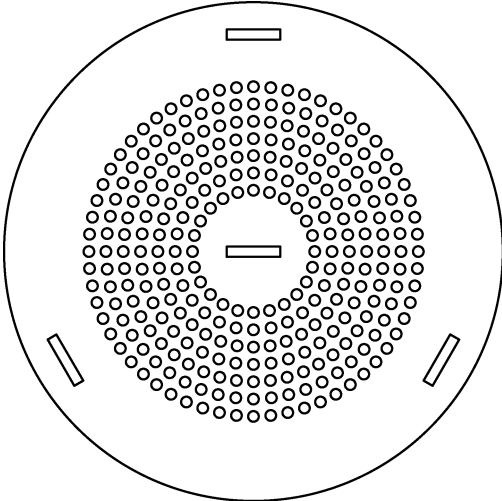

Optional Infrared (IR) Wall Controls

Gold is equipped with two (2) integrated infrared eye ports, one for each OP. This allows for either a wall keypad or remote control with a wall IR Eye (both sold separately) to be used to adjust the system. Adjustments to the system may be made for the masking volume or the audio channel.

Connect the Gold IR Keypad or Eye Wallplate back to the Gold unit using standard cable with an RJ45 connection.

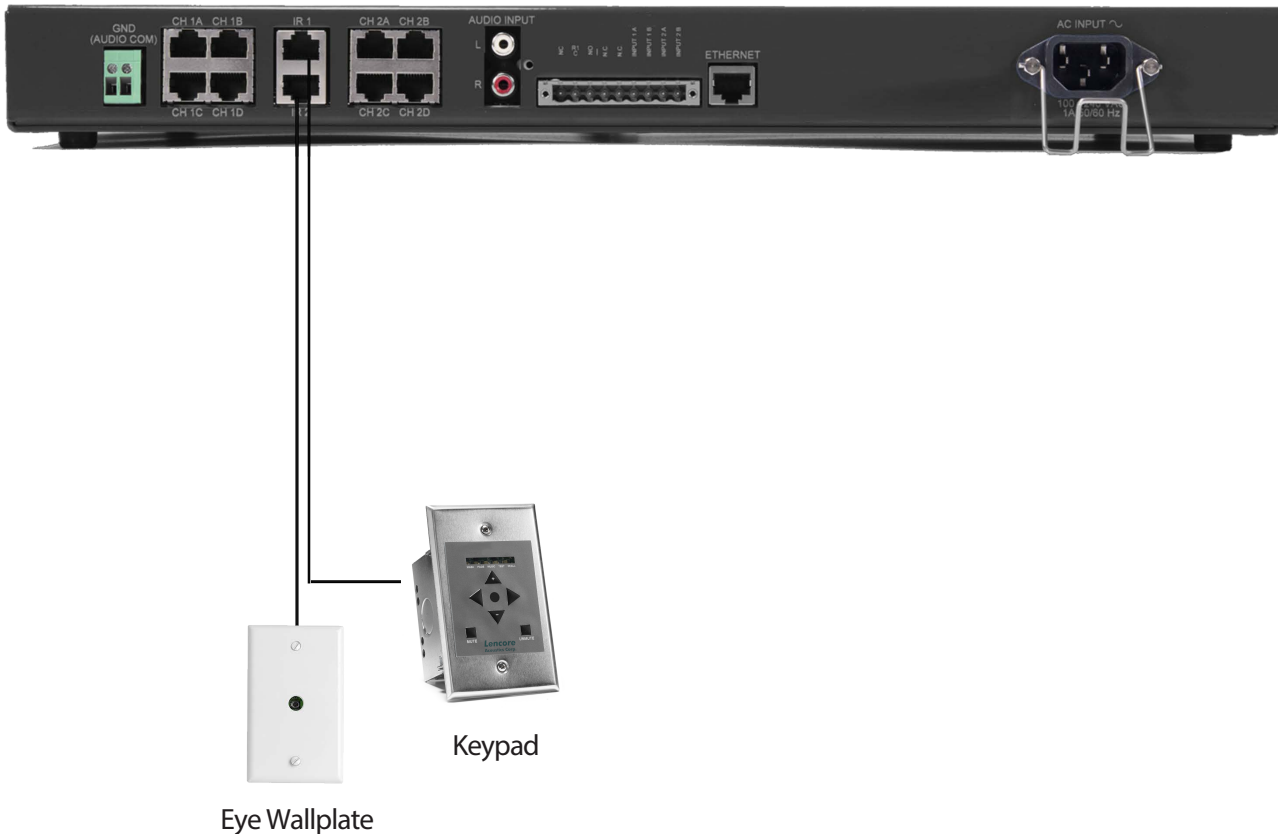

Programming the IR Touch Pad Controller

The configuration of the IR Touch Pad controller (sold separately) is done through dip switches located on the back side of the board (see diagram).

The list below shows all possible configurations for the IR Touch Pad. Configurations will allow you to: control individual channels such as Channel A, B, C, D (individually) or ALL Channels, also configure whether or not the buttons on the front panel of the IR Touch Pad are active or not and if the IR sensor is active or not.

To configure dip switches: locate the back of the IR Touch Pad and turn board to the right 90 degrees. The RJ45 connector receptacle will now be oriented towards the right. The small pins numbered 1-8 will now be in the middle left of the board. These small pins can be set to either "UP" or "DOWN" which can be done with a small screwdriver.

Use the list below to find what dip switches need to be changed for your particular install.

IR TOUCH PAD CONTROLLER CONFIGURATION

Front of Wall Plate

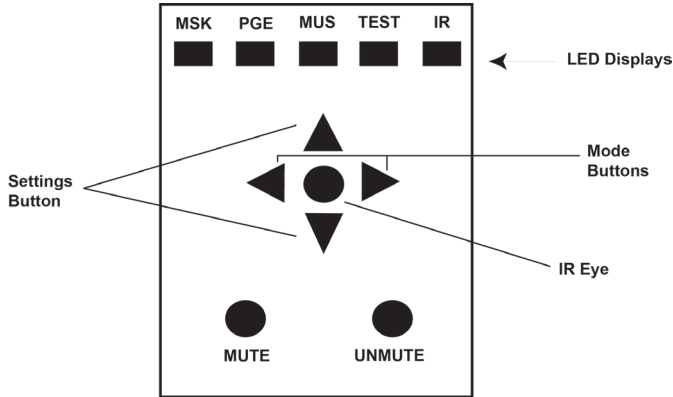

The IR Touch Pad Controller comes with all dip switches in the down position by default.

This default setting will allow the IR Touch pad controller to be used with the IR Hub model G482 out of the box. If you do not have the IR Hub model G482 you can connect the IR touch pad directly to an OP. This will require configuration.

*IR touch pad can control one individual channel or all channels.

Back of Wall Plate (board turned right 90°)

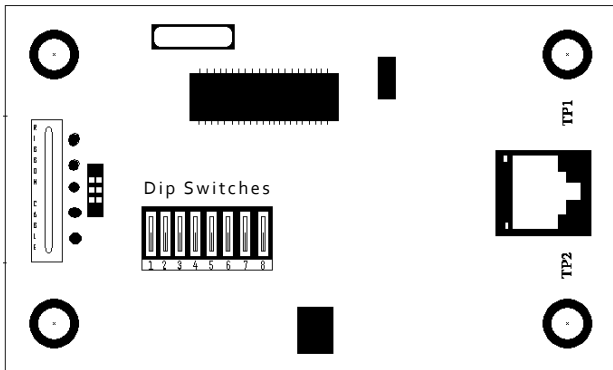

Exploded View: Dip Switches (on board turned right 90°)

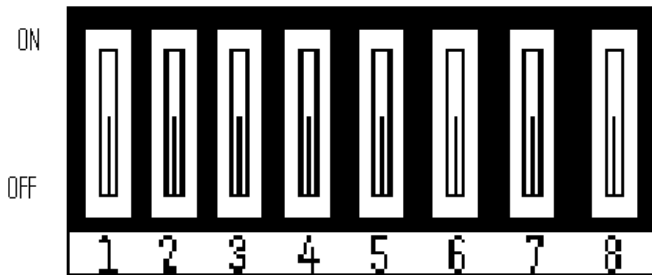

IR TOUCH PAD CONTROLLER CONFIGURATION MANUAL

The IR Touch pad, without a Hub, can be configured to control a single channel or all 4 channels not a combination of channels.

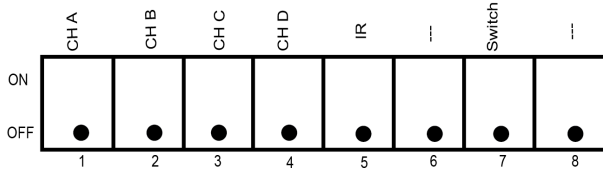

Hub Position

- Use this position when using an IR Hub
- All DOWN

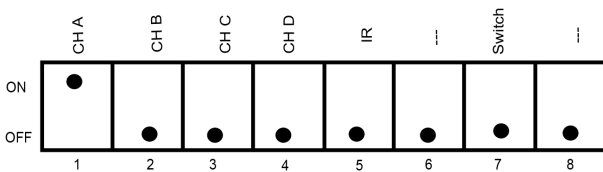

Channel A Only

- No Hub, Direct to OP-IR Port
- #1 UP- All else DOWN

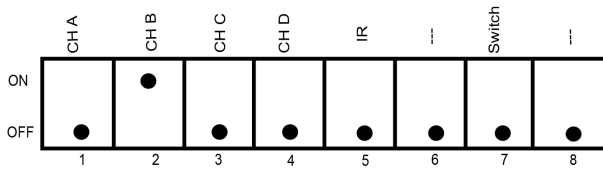

Channel B Only

- No Hub, Direct to OP-IR Port
- #2 UP- All else DOWN

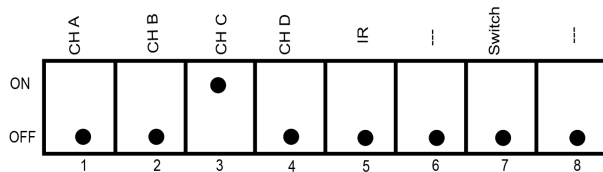

Channel C Only

- No Hub, Direct to OP-IR Port
- 3 UP-All else DOWN

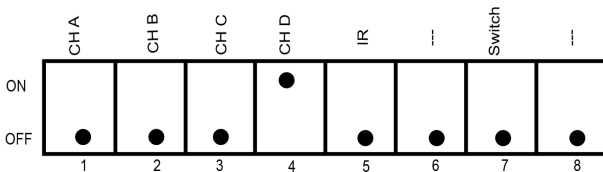

Channel D Only

- No Hub, Direct to OP-IR Port
- #4 UP- All else DOWN

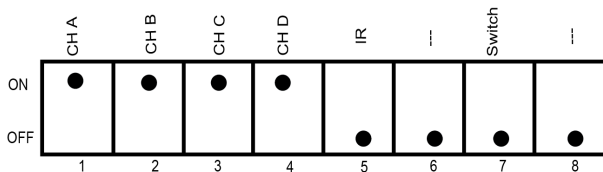

Ch A,B,C,D = ON

- No Hub, Direct to OP-IR Port
- #1,2,3,4 = U

Tuning and Balancing

With the sound masking off and using a sound pressure meter (or App off of your smart device), start by measuring the existing ambient sound level. The device should point up when taking your measurement and should be approximately 4' off of the floor. Sound levels are measured in decibels, or dB. The Sound Pressure Level (SPL), or "loudness," is what you are measuring through an "A" Weighting Curve – which accounts for the relative loudness perceived by the human ear.

Gold has two OP's with four channels per OP – for a total of eight (8) channels. Both OPs produce sound masking. By connecting an Ethernet cable (Cat5e or Cat6) to the Ethernet Connection and a PC, you are able to access System Manager – the network interface that allows easy system adjustments (reference System Manager Manual available at www.lencore.com and/or see the Quick Start System Manager Guide in this manual.)

If you have established or are establishing zones, reference your drawings. Walk your space, with the HVAC operating in its normal state, to take baseline readings on your S.P. meter. Mark these measurements down for each area. Different spaces such as hallways, open work rooms, closed rooms, etc., treat sound differently and will need to be tuned independently. Tuning and Balancing utilize sound measuring tools such as hardware and software, as well as your own ears. It must sound comfortable to you. NOTE: Masking levels that are too low will not mask speech effectively! Typically you will want to target the sound masking levels for the following:

Open Space	48 dB
Closed Office / Room	42 – 45 dB
Corridors / Hallways	Set levels to transition seamlessly

Quick Start Guide: System Manager

System Manager is Lencore's graphic user interface that allows sound masking system adjustments to be made via a PC in a simple, easy manner. System Manager interfaces with Gold via the Ethernet Connection port on the back of the unit. System Manager acts like a website but resides inside the device itself. No internal or external network is required but it can be incorporated into your network (contact Lencore Support to make this connection: 516-682-9292 or support@lencore.com).

Connect a computer to your device's Ethernet port using a standard RJ-45 network cable (Cat5e or Cat6).

The computer must be configured properly with an IP Address that is different from the device. Follow this sequence:

Access Network Settings

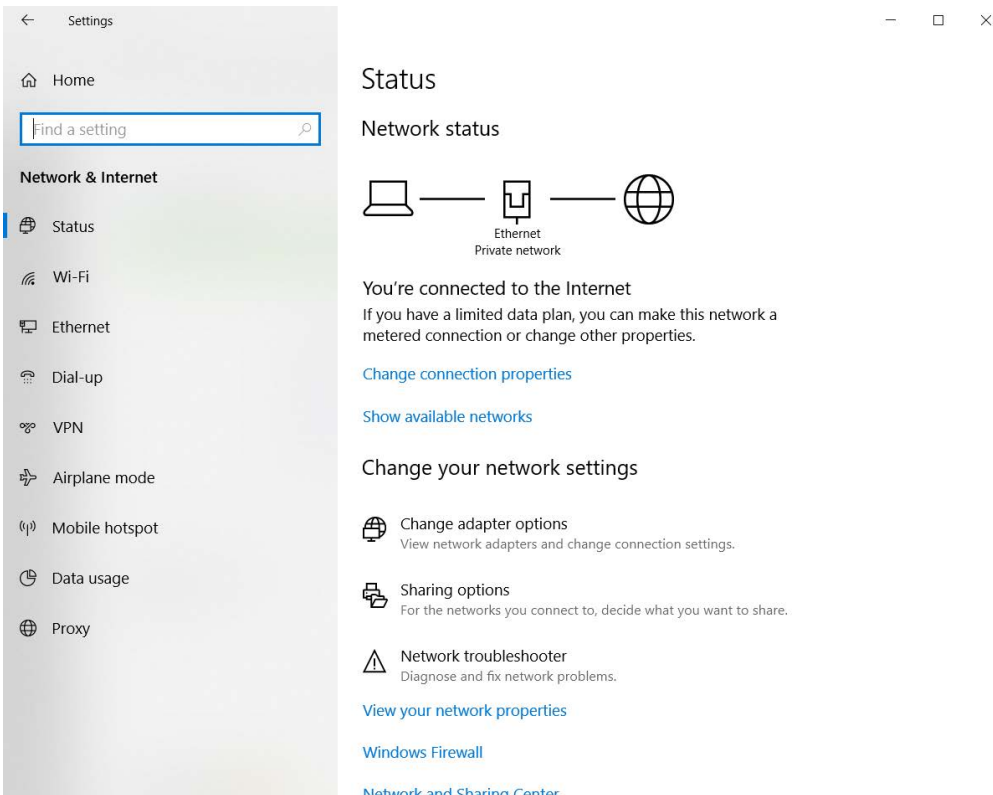

The screenshot shows the Windows Settings application. On the left, the 'Network & Internet' category is selected, and the 'Status' option is highlighted. The main pane displays the 'Status' section for 'Network status'. It shows a diagram of a laptop connected to an Ethernet network (represented by a plug icon) and the Internet (represented by a globe icon). Below the diagram, it states 'You're connected to the Internet' and provides a tip about limited data plans. Several links are available: 'Change connection properties', 'Show available networks', 'Change your network settings', 'Change adapter options', 'Sharing options', 'Network troubleshooter', 'View your network properties', 'Windows Firewall', and 'Network and Sharing Center'.

Change Adapter Settings

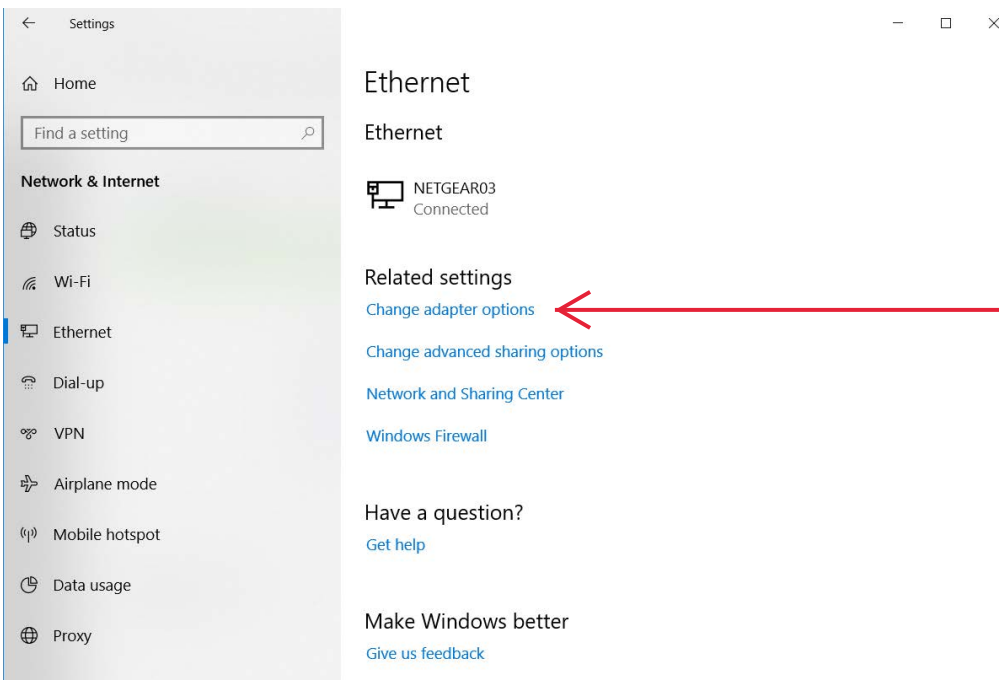

The screenshot shows the Windows Settings application with 'Network & Internet' > 'Ethernet' selected. The main pane displays the 'Ethernet' settings for the 'NETGEAR03' adapter, which is 'Connected'. Under the 'Related settings' section, the 'Change adapter options' link is highlighted with a red arrow. Other links include 'Change advanced sharing options', 'Network and Sharing Center', and 'Windows Firewall'. At the bottom, there are sections for 'Have a question?' with a 'Get help' link, and 'Make Windows better' with a 'Give us feedback' link.

Right click on your Ethernet connection Click Properties

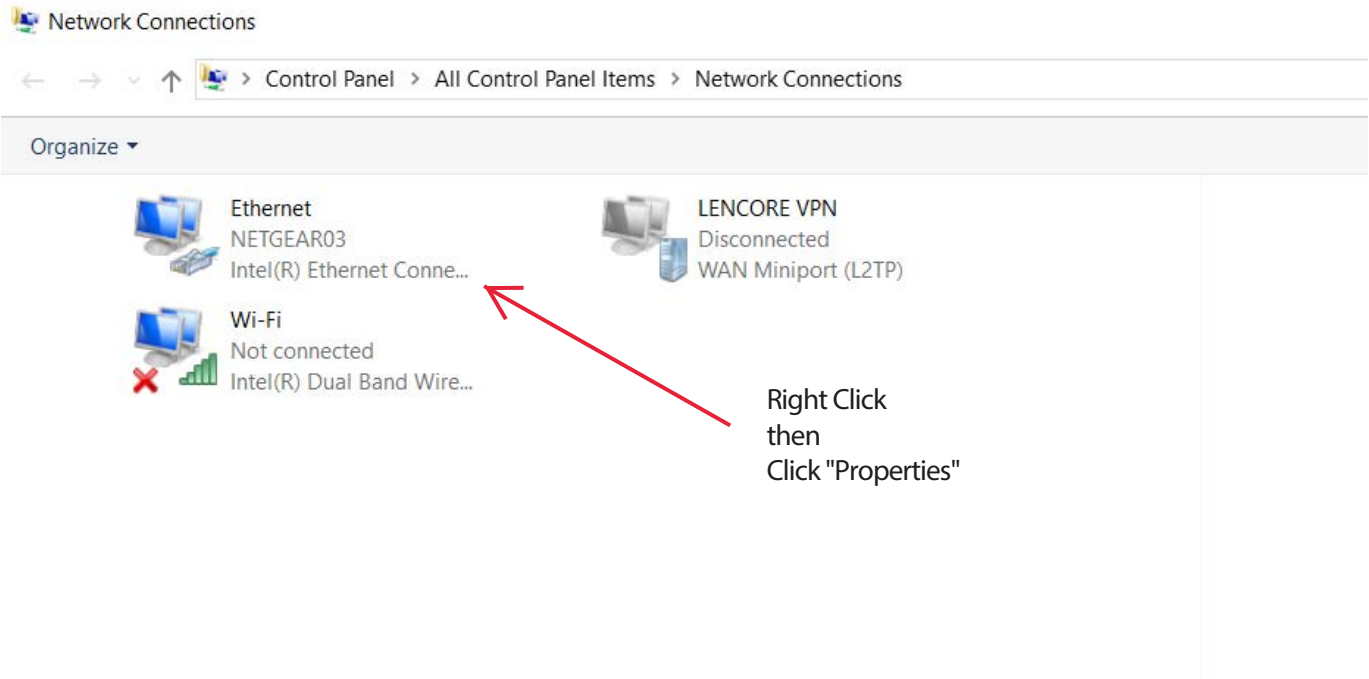

Highlight "Internet Protocol Version 4 (TCP/IPv4)" and click Properties

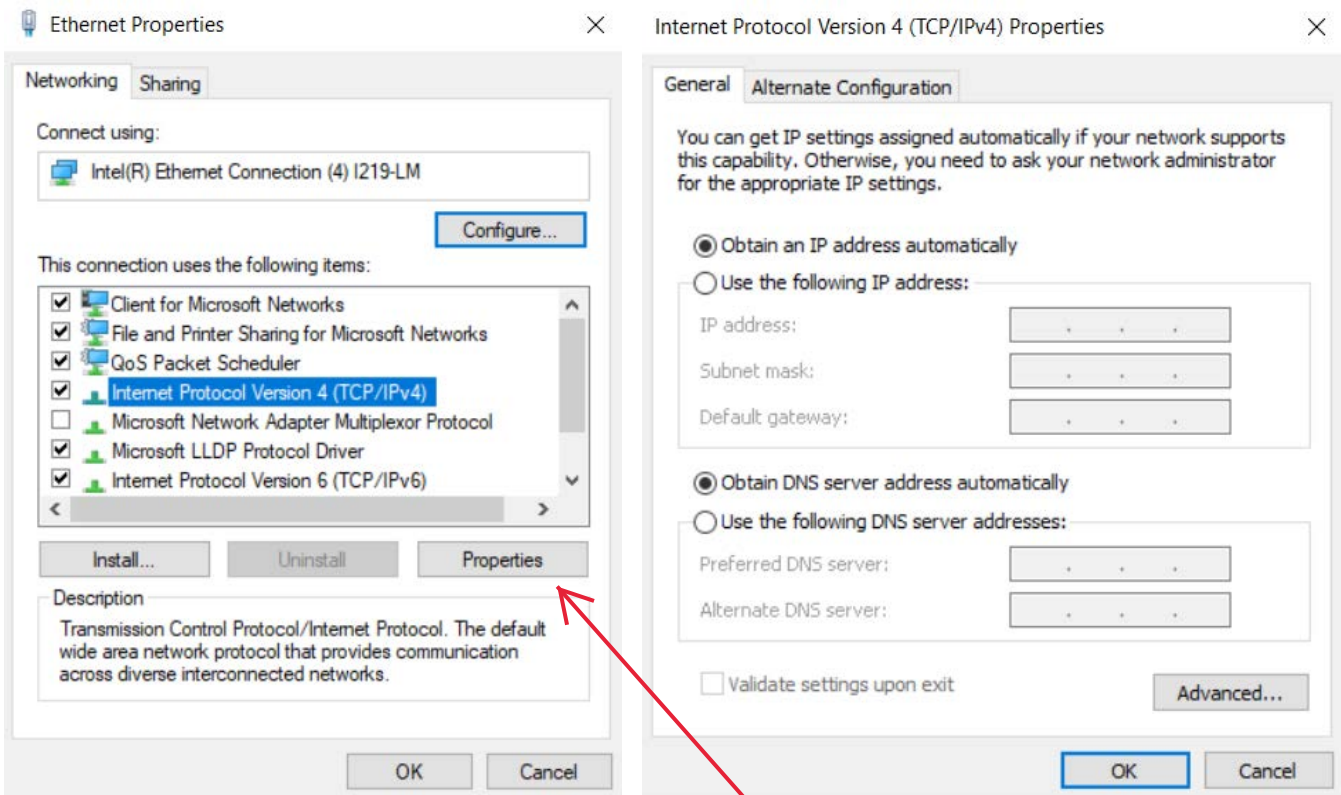

Click "Use the following IP Address" radial button and type in the following: 192.168.100.200 It should look like the following:

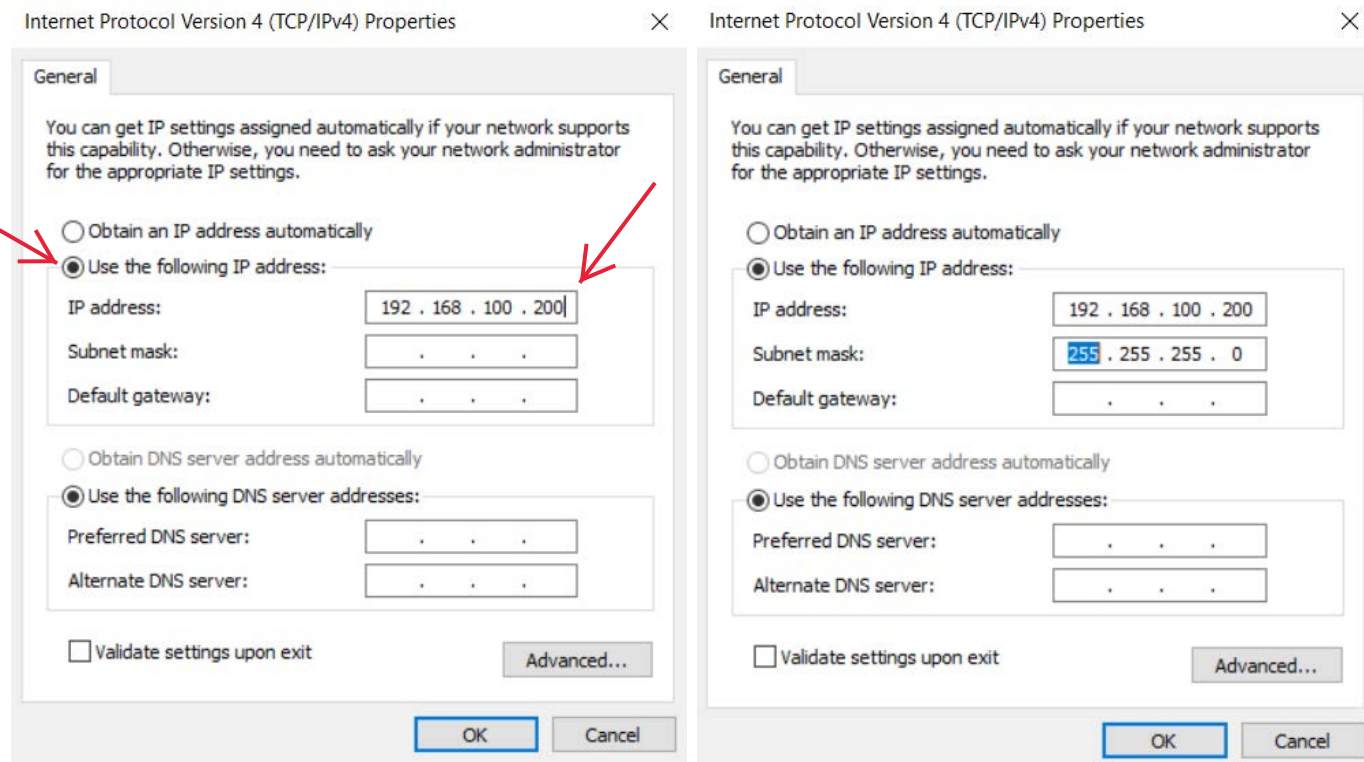

Click "OK" and exit out of set-up.

Access any Internet browser (Chrome, Safari, Internet Explorer, etc.) on your computer.
In the URL address box type: 192.168.100.225.

NOTE: This ID number is different from the set-up ID number.

The System Manager Login Screen should appear:

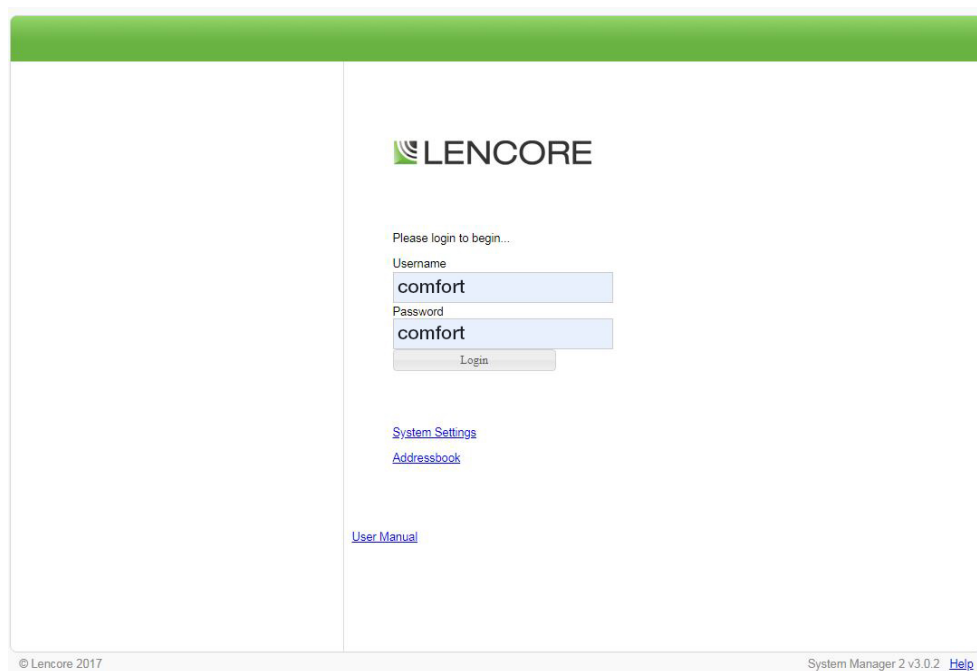

© Lencore 2017 System Manager 2 v3.0.2 [Help](#)

The login default settings are:

Username: comfort

Password: comfort

After logging in you will be presented with five tabbed options to select from:

- Devices - allows you to select the OP for System (Volume and Contour) adjustments per Channel
- Zone - refer to the full System Manager manual for this feature
- EQ - refer to the full System Manager manual for this feature
- Sources - refer to the full System Manager manual for this feature
- System - allows you to save system settings

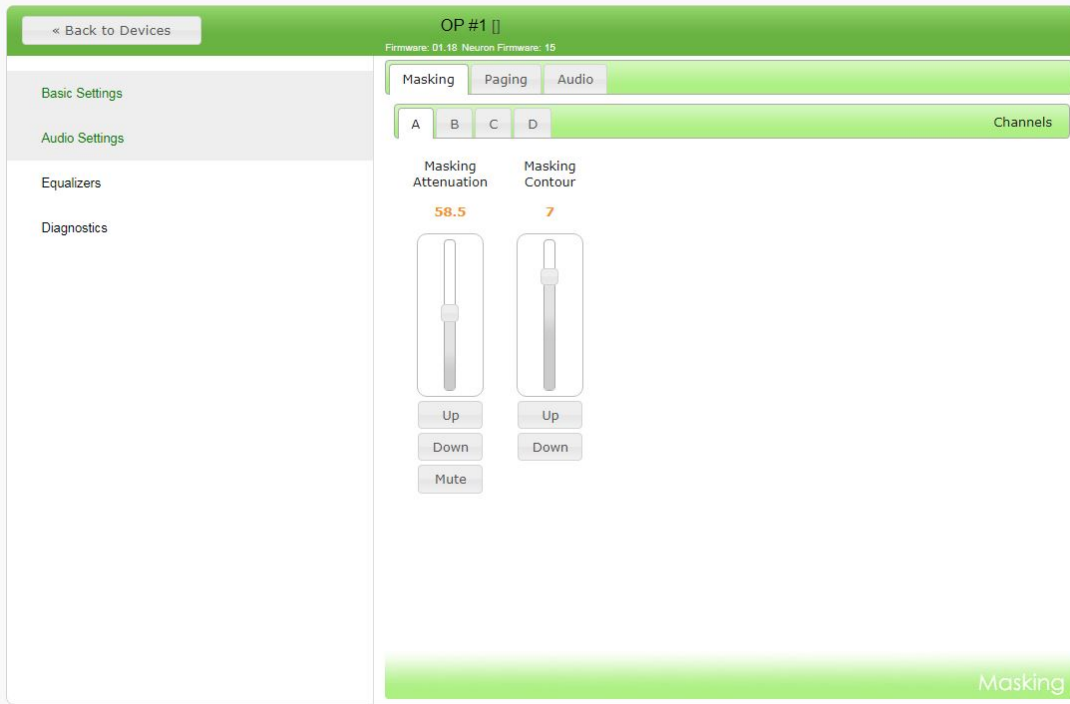

Clicking on an OP will bring up the Controls and Tabs for that OP.

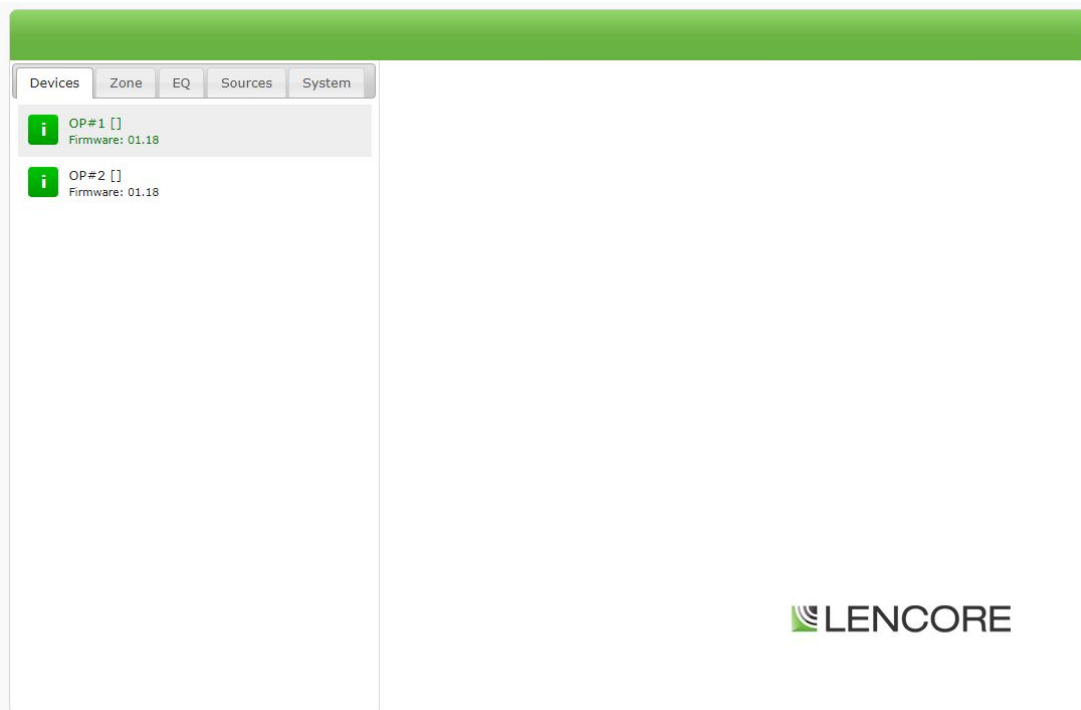

You are able to adjust the masking volume and contour by moving the slider itself up and down, clicking the “Up”, “Down”, and “Mute” buttons or by clicking on the value and keystroking in a new number. Each channel is adjusted independently. Typically your final decibel level will be arrived at by adjusting both the masking attenuation (volume) and contour (frequency) controls.

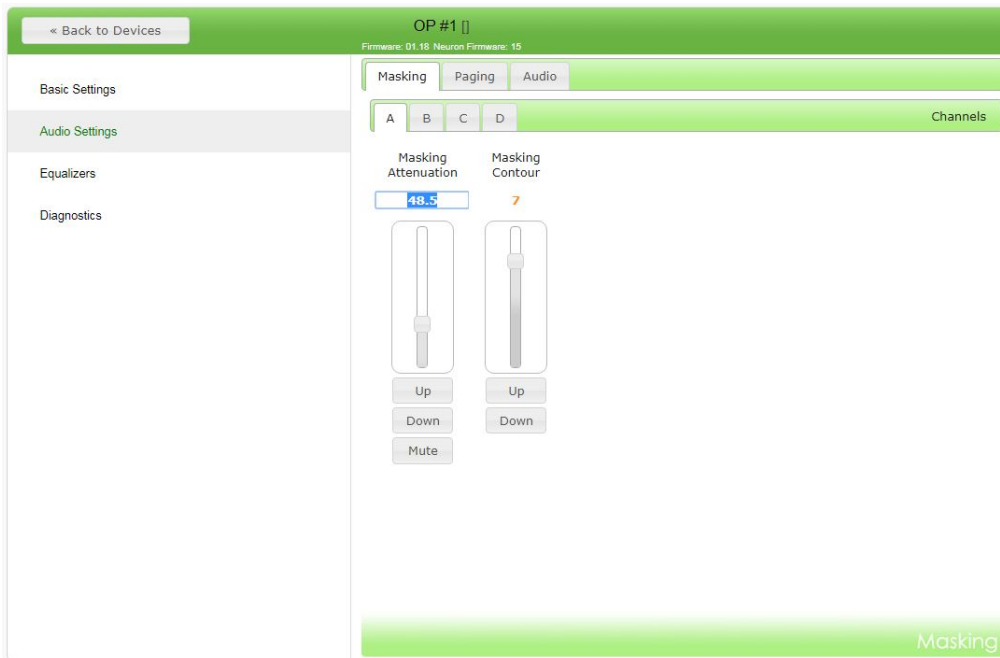

Always check your levels!

If your decibel levels are too low, the space may feel comfortable however you will not be effectively masking speech.

Final Step.

Once you have completed the Tuning and Balancing it is time to save your changes to flash.

Navigate to the System Tab.

Click “Save All to Flash” which saves your current settings to an internal flash memory. If you fail to take this step and power is turned off within the first two hours the settings will revert back to their previous settings.

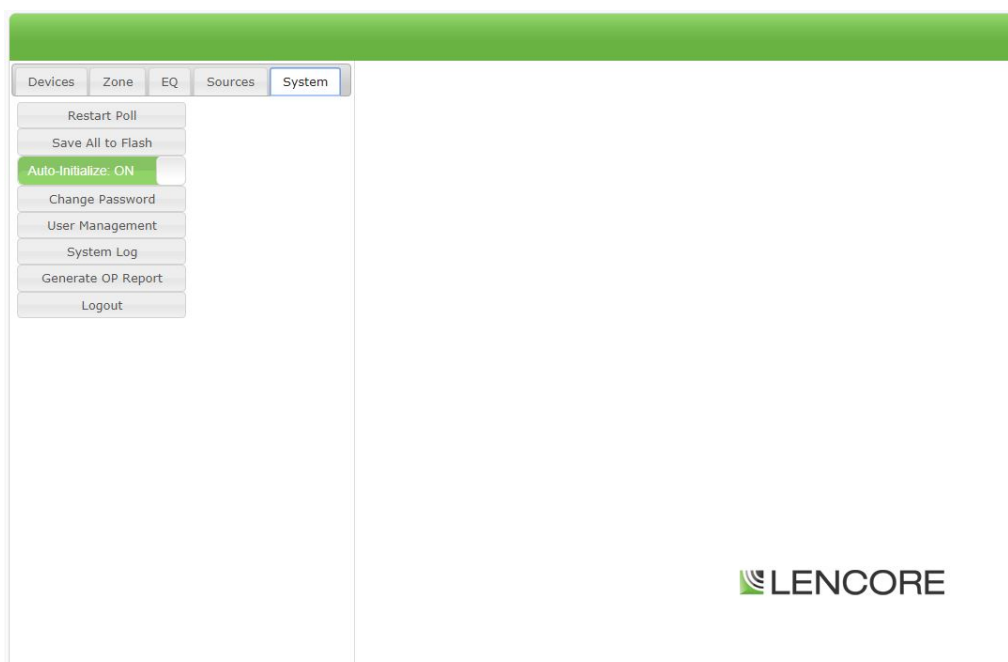

Zone Tab

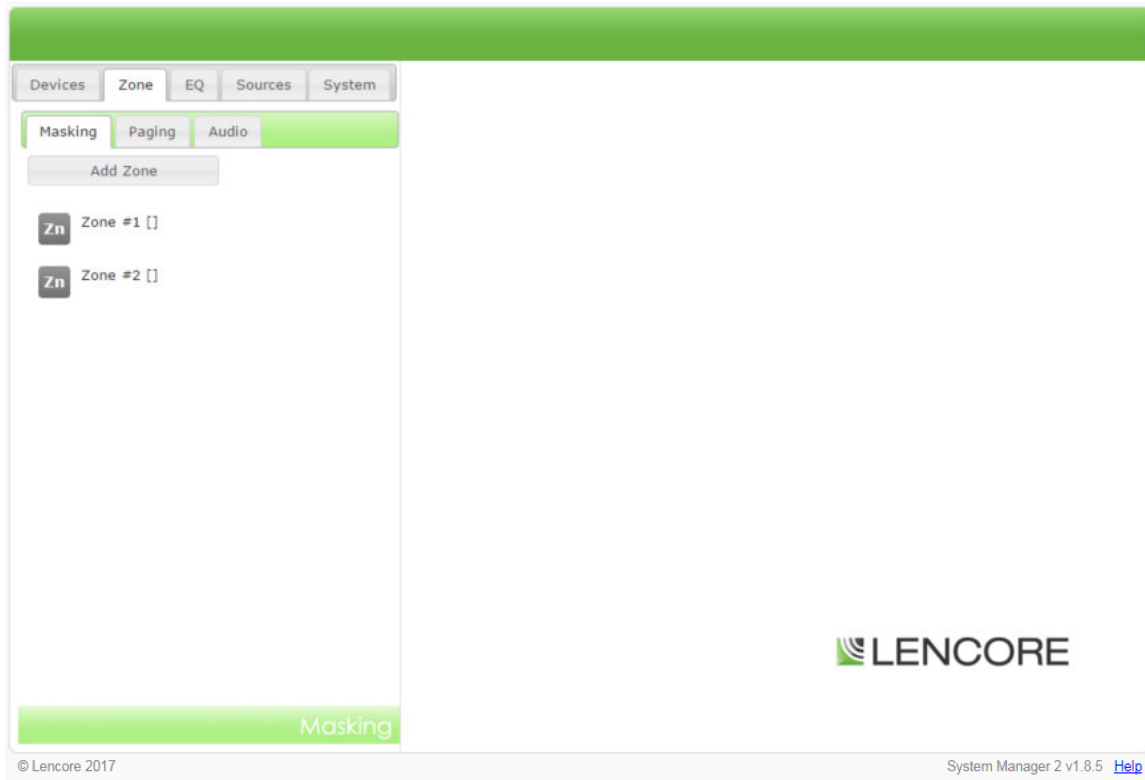

Zones are groups of OP channels. They allow you to combine and control multiple channels at the same time.

The Zone tab, when first selected, presents you with a sub-menu of tabs for each type of zone available: Masking or Audio. Selecting either of these tabs will present a list consisting of all of the zones that have been added to the system for the selected zone type as well as a button for adding a new zone of the selected type.

Each individual Zone item consists of the following information:

- Grey “Zn” Icon
- Zone # and Friendly Name. Friendly name is assignable once the Zone has been selected and will be blank if no Friendly Name has been assigned.

Selecting one of the Zones will bring you to the Zone Editing screen which will allow you to adjust several attributes of the zone.

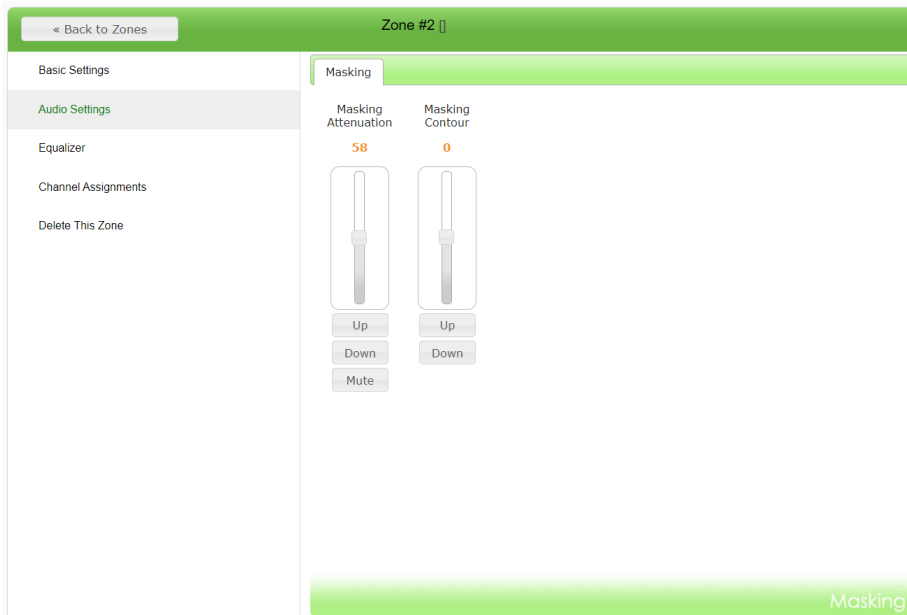

The Zone Tab defaults to the Audio Setup where you can adjust the volume and the contour for sound masking (you can adjust the volume for the audio when in the Audio tab.)

Use the sliders, the Up, Down and Mute buttons, or, highlight the values themselves and type in a value to adjust the volume and contour.

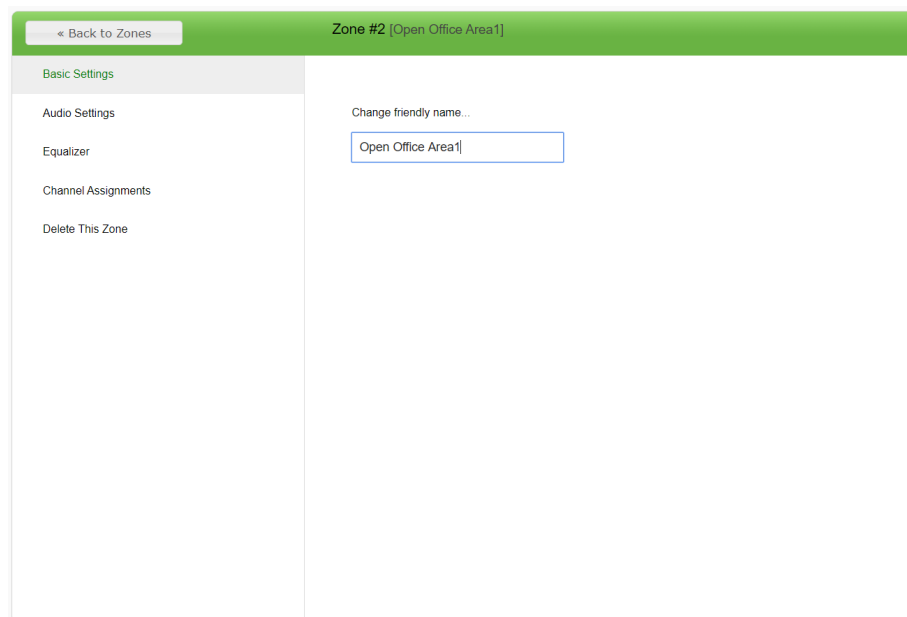

By clicking the Basic Settings link you have the ability to name the zone in order to more easily identify which area you are adjusting.

The Zone Name will be identified in the brackets next to the Zone # (i.e., in this case at the top of the screen it states: Zone #2 [Open Office Area1])

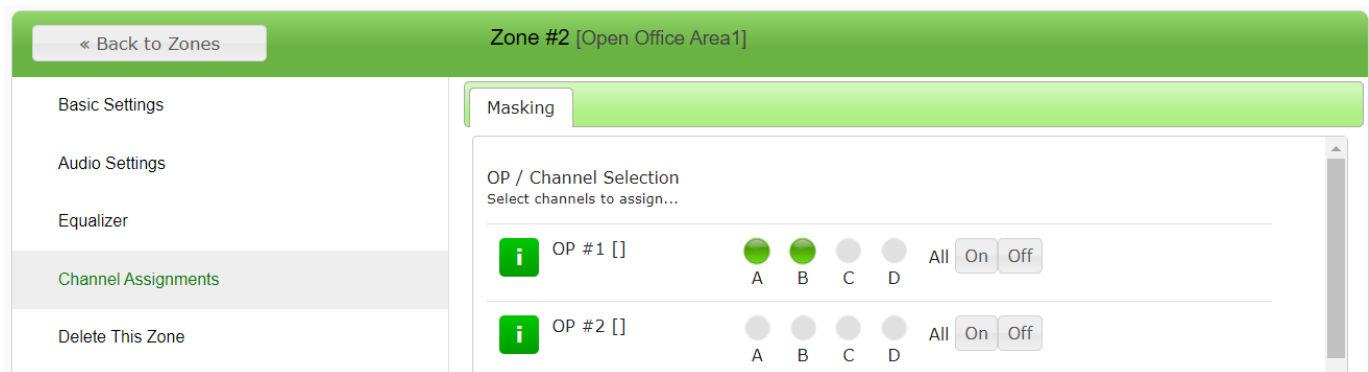

Channel Assignments are the heart of the Zone development. Each channel controls up to eight (8) speakers. By assigning channels to a zone you are able to easily

adjust areas all at once whether it is changing the sound masking or adjusting the music.

Zone #2 [Open Office Area1]

Basic Settings

Audio Settings

Equalizer

Channel Assignments

Delete This Zone

Masking

Graphic EQ

Equalizer Selection
Select EQ to load...

EQ #2 []

EQ #3 []

EQ #4 []

Masking

System Manager allows you to adjust the EQ of the sound masking or the Music input and apply it against that entire zone.

NOTE: In most instances, the equalizer should not be adjusted unless there is a specific curve you want to apply. Lencore sets the masking at a comfortable curve out of the box.

Zone #2 [Open Office Area1]

Basic Settings

Audio Settings

Equalizer

Channel Assignments

Delete This Zone

Are you sure you want to delete this zone?

Delete Zone

You have the flexibility to delete zones by clicking on the Delete This Zone link. Just confirm by clicking on the Delete Zone box.

Setting the IP Settings

1. If using the SMC Toolbox application, follow the steps above to change or view IP settings
2. If not using the SMC Toolbox application, power on the Head End and wait about 2 minutes. (The AUX LED will be flashing while booting up, and solid once complete.)
3. Click the "Func" button on the front of the Head End until you get to the "IP Info" section.
4. The current IP address will be displayed.
5. Use the "Opt" button to cycle through additional IP settings including: Subnet, Gateway, and MAC ID.
6. We can also change the IP settings by navigating the IP address displayed on the Head End display.

Changing the IP Settings using the System Manager Webpages

1. Make sure your static IP is set on your PC and you have internet connection going from your PC to the "Processor Field Pop Enabled" port on the back of the Headend. (See Interfacing with the protonode section of the manual for further instructions).
2. Open a web browser and enter the Headend IP address.
3. On the Lencore landing page, select the "Systems Setting" option.

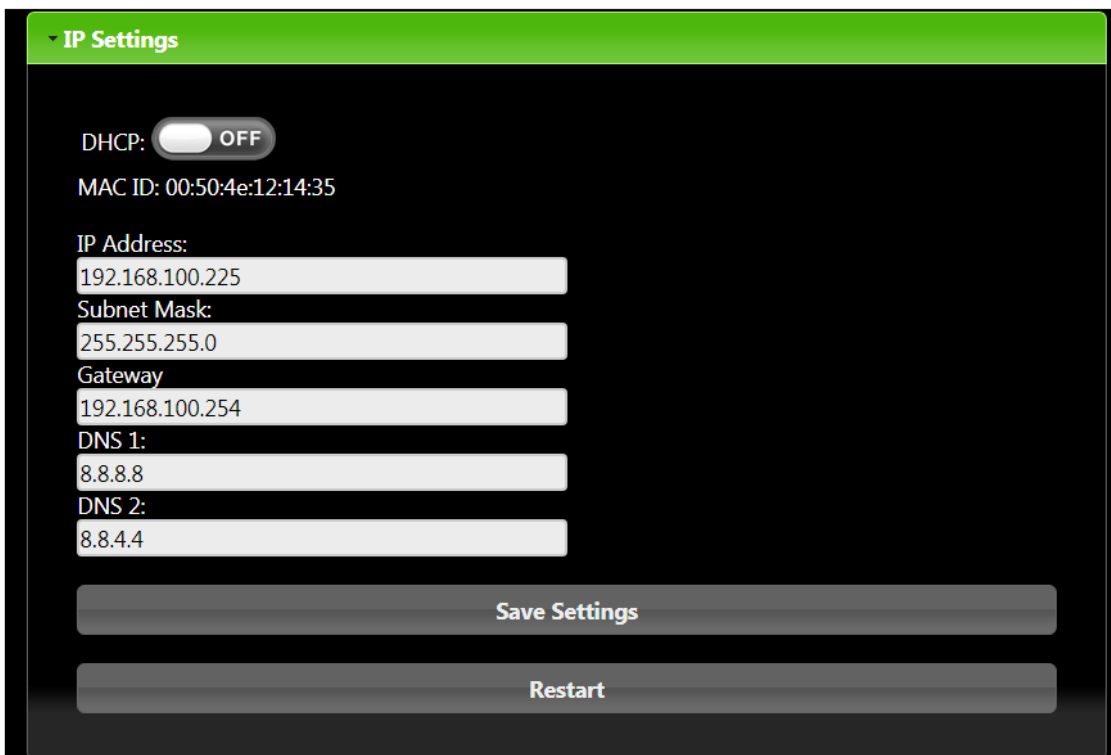

IP Settings

DHCP: OFF

MAC ID: 00:50:4e:12:14:35

IP Address:
192.168.100.225

Subnet Mask:
255.255.255.0

Gateway
192.168.100.254

DNS 1:
8.8.8.8

DNS 2:
8.8.4.4

Save Settings

Restart

NOTE: Here you can view or change the IP settings for the Head End. Be sure to hit "Save Settings" after making changes. You will also need to restart for changes to take effect. To confirm settings wait 2 minutes after hitting "Restart" then using the Head End display navigate to the IP settings section.

USER OPERATION

NOTE: Once set up is complete, follow the set-up steps to access the TCP/IPv4 properties like before. Click the “Obtain IP Address Automatically” radial button and click “OK”

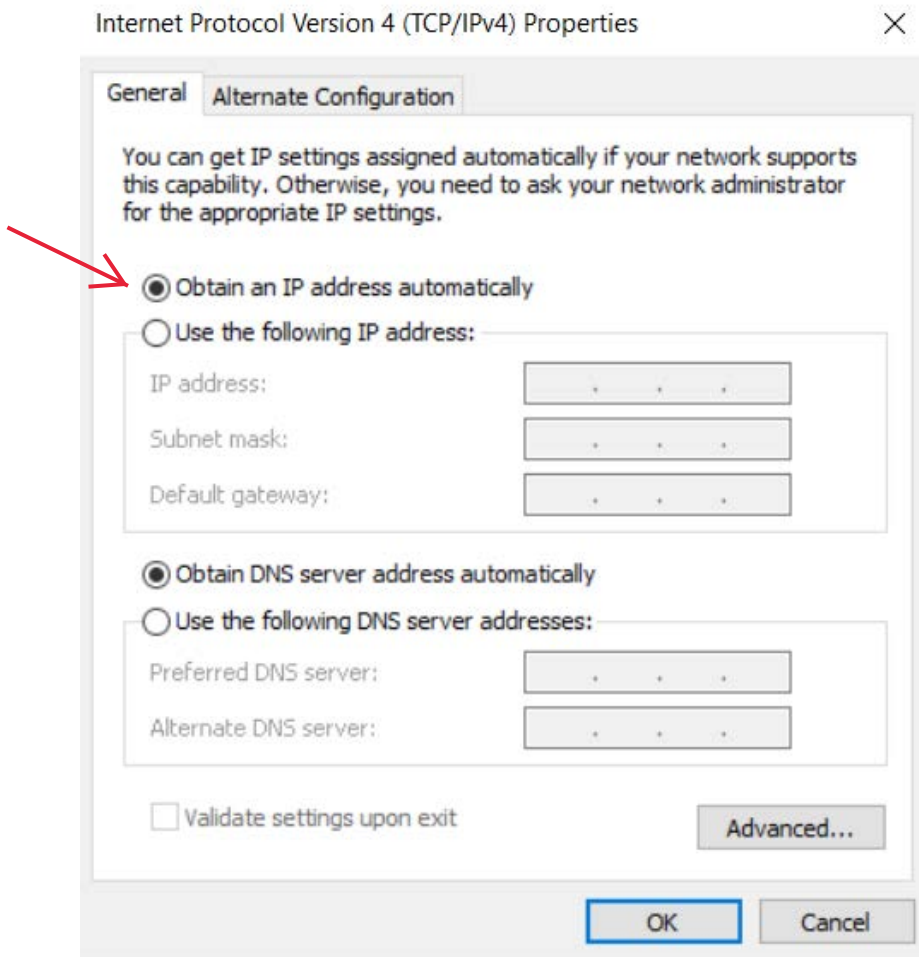

Your set-up is now complete. Enjoy your Gold System and the best sound masking in the market. If you have any questions or need assistance our team of Technical Support Experts and Customer Service Managers are always here to assist you: 516-682-9292 or support@lencore.com

OPERATING THE SYSTEM FROM THE FRONT PANEL

Front Panel Buttons:

The buttons allow the user to make a number of adjustments to the system without using a computer, although, a computer and System Manager are still required for full control of all functions (see previous section to access the Network and login to System Manager). A selection can be made by continually pressing and releasing the button.

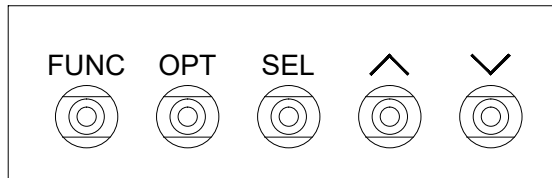

The display shows OP operational data:

The upper left part of the display displays the Function. The upper right displays the current Option, within that function. The lower left displays the Channel or Zone # that is related to the function. The lower right displays the value associated with that channel or zone.



The **FUNCTION** button selects the function to be changed. The **OPT** button selects the operation.

The up and down *arrows* increment and decrement the settings.

The **SEL** key is used to select operations.

To use the keypad, first choose the **FUNCTION** of operation. After the function has been selected, use the **OPT** key to select the option. Finally, use the up and down *arrows* to change the value for the function.

Options and Functions:

Function	Option	Select
Masking Volume	OP	OP Channel Volume
	ZN	Zone Volume
Masking Contour	OP	OP Channel Contour
	ZN	Zone Contour
Masking Mute	OP	OP Channel Mute
	ZN	Zone Mute
Music Volume	OP	OP Channel Volume
	ZN	Zone Volume

Function	Option	Select
Music Mute	OP	OP Channel Mute
	ZN	Zone Mute
IP Info	IP Address Subnet Gateway MAC ID	View Only View Only View Only View Only
RCA Volume	Up* Down*	Select Select
Faults	None	Select
Voltages	None	View Only
Neuron Version	None	View Only

**Not selected per OP, but the audio coming into the system.*

Operation Examples:

Masking Volume:

Press the **FUNC** button until "Mask Vol" is displayed.

OP/Channel:

Press the **OPT** button until "OP" is displayed.

Press the **SEL** button until the cursor is on the value to change (OP number, channel letter, or volume). Both OP's (OP ALL) or individual OP's (OP1 or OP2) or individual channels (A,B,C,D) can be selected.

Use the up and down *arrows* to increment and decrement the selected value.

Zone:

Press the **OPT** button until "ZN" is displayed.

Press the **SEL** button until the cursor is on the value to change (Zone number or volume). Use the up and down *arrows* to increment and decrement the selected value.

Masking Contour:

Press the **FUNC** button until "Mask Cntr" is displayed.

OP/Channel:

Press the **OPT** button until "OP" is displayed.

Press the **SEL** button until the cursor is on the value to change (OP number, channel letter, or volume). Both OP's (OP ALL) or individual OP's (OP1 or OP2) or individual channels (A,B,C,D) can be selected.

Use the up and down *arrows* to increment and decrement the selected value.

Zone:

Press the **OPT** button until "ZN" is displayed.

Press the **SEL** button until the cursor is on the value to change (Zone number or volume). Use the up and down *arrows* to increment and decrement the selected value.

Masking Mute:

Press the **FUNC** button until "Mask Muter" is displayed.

OP/Channel:

Press the **OPT** button until "OP" is displayed.

Press the **SEL** button until the cursor is on the value to change (OP number, channel letter, or volume). Both OP's (OP ALL) or individual OP's (OP1 or OP2) or individual channels (A,B,C,D) can be selected.

Use the up and down *arrows* to increment and decrement the selected value.

Zone:

Press the **OPT** button until "ZN" is displayed.

Press the **SEL** button until the cursor is on the value to change (Zone number or volume).

Use the up and down *arrows* to increment and decrement the selected value.

Paging Functions have no relevance for this unit.

Faults:

Press the **FUNC** button until "Faults" is displayed.

Press the **SEL** button until the cursor is on the value to change (Clear, Mute, Fault number).

Use the up and down *arrows* to scroll through the fault list.

If the cursor is on Clear or Mute, the up or down arrow will clear or mute the fault.

The **OPT** button has no use for Faults.

I/O Setup:

Press the **FUNC** button until "I/O Setup" is displayed.

I/O number:

Press the **SEL** button until the cursor is on the I/O number.

Use the up and down *arrows* to increment and decrement the I/O number.

I/O options:

Press the **SEL** button until the cursor is on the I/O options.

Use the up and down *arrows* to change the I/O to Supervised, Normal, or Disabled.

Note: A Supervised input must include an EOL (end of line) resistor. A Normal input does not need an EOL resistor.

Voltages:

Press the **FUNC** button until Voltages is displayed.

Press the **OPT** button to select the various voltages to display.

Note: Voltages cannot be changed, they can only be monitored.

Front Panel Indicators

Neuron activity

The Neuron is a specialized internal microprocessor. The LEDs labeled TX and RX indicate Neuron activity. These LEDs will be flickering under normal operation.

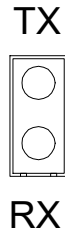

FLT

The FLT LEDs are indicators for system faults. The CPU LED indicates that the internal CPU (microprocessor) is in a fault condition. The GEN LED indicates a general fault condition. When either of these LEDs is on, a system fault has occurred.

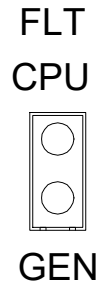

PWR/SPL

A green PWR (Power) LED indicates that the internal power supplies are operating. The SPL LED is on when the serial connection is in use.

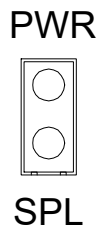

Inputs

The INPUTS LEDs are indicators for system inputs. FTR1 represents the Mute masking input.

FTR1

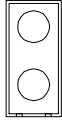

FTR2

Relays

Relay RL1 LED indicates a general fault. When the LED is on, no fault exists and Relay RL1 is energized. When the LED is off, a fault has occurred and Relay RL1 is de-energized. AUX LED is for future use.

RL1

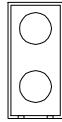

AUX

Processor

The Processor LEDs indicate the state of the Processor.

The ERR LED will go on solid 15 seconds after power up. It will turn off after 5 seconds. A steady red light will indicate there is a system error on the unit. The RUN LED will start flashing 20 seconds after power indicating normal operation. The SPL LED will be off for normal operation.

PROCESSOR

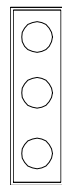

ERR

RUN

SPL

Troubleshooting Speaker Lines

- To check all speaker wires and speakers for their integrity simply unplug the 1st speaker wire from the i.Net OP and connect an RJ45 to an 8 conductor CAT5 wire on one end and twist wire/pins 1, 2, 3,4 together and 5, 6, 7, 8 together.
- This will give you two leads plus & minus.
- Attach an OHM meter to the wire with the leads and attach the other end into the first or last speaker in a run of speakers using an RJ45 coupler.
- If all is connected correctly, you will see approximately the following correct results on your OHM meter:

# of Speakers	OHMs-K
1	26
2	13
3	8.67
4	6.5
5	5.2
6	4.33
7	3.71
8	3.25

Lencore Acoustics LLC
516-682-9292
info@lencore.com
www.lencore.com